

S-38.2121 Routing in Telecommunication Networks

Prof. Raimo Kantola
raimo.kantola@hut.fi, Tel. 451 2471
Reception SE323, Wed 10-12

Lic.Sc. Nicklas Beijar
nbeijar@netlab.hut.fi, Tel. 451 5303
Reception: SE327, Fri 10-11

Assistant: Abu Rashid

Information

Course home page:
<http://www.netlab.hut.fi/opetus/s382121/>

Newsgroup:
opinnot.sahko.s-38.tietoverkkotekniikka

Agenda – Fall 2007

Lectures Wed 14-16 in hall S4 and
 Fri 8-10 in hall S4
 In English
 Period I

Exercises Thu 12-14 in hall S3
 In English

Exam Mon 31.10.2007 13-16 in hall S4

Agenda – Fall 2007

Day	Time		Topic	Lecturer
Wed 12.9	14-16	Lecture 1	Routing in circuit networks 1	RKa
Fri 14.9	8-10	Lecture 2	Routing in circuit networks 2	RKa
Wed 19.9	14-16	Lecture 3	Routing in the Internet: IP, ICMP, ARP, routing vs. switching	NB
Thu 20.9	12-14	Exercise 1		AR
Fri 21.9	8-10	Lecture 4	Distance vector routing: Principles, Bellman-Ford	NB
Wed 26.9	14-16	Lecture 5	Distance vector routing: RIP, RIP-2	NB
Thu 27.9	12-14	Exercise 2		AR
Fri 28.9	8-10	Lecture 6	Link state routing: Principles, Dijkstra	NB
Wed 3.10	14-16	Lecture 7	Link state routing: OSPF	NB
Thu 4.10	12-14	Exercise 3		AR
Fri 5.10	8-10	Lecture 8	CIDR	NB
Wed 10.10	14-16	Lecture 9	Multicast routing 1: Algorithms, graph theory	NB
Thu 11.10	12-14	Exercise 4		AR
Fri 12.10	8-10	Lecture 10	Multicast routing 2: IGMP, DVMRP, PIM, MOSPF	NB
Wed 17.10	14-16	Lecture 11	Mobile IP, Introduction to IPv6	NB
Thu 18.10	12-14	Exercise 5		AR
Wed 19.10	14-16	Lecture 12	Routing in Ad hoc networks	NB

Agenda – Fall 2007



Material

- A. Girard: *Routing and dimensioning in circuit switched networks*
 - Chapters 1 and 2.
- C. Huitema: *Routing in the Internet*
 - The 2nd version is recommended.
 - Chapters 1-6, 9-10 and 12-13.
- Specifications, RFCs, and Internet-drafts
 - Downloadable, links on course page
- Course handouts (via Edita) in English
 - Both Finnish and English versions on course homepage



Course requirements

- **Goal:** to understand routing on a functional level in different networks.
- **Requirements:** Exam + $\frac{1}{2}$ of the exercises correctly solved and submitted

Exercises

- 5 exercises
- Exam points
 - -4 (no exercises done) ... +4 (all exercises done correctly)
- Return your answers before the exercise lecture begins
 - E.g. return the answers of exercise round 1 before exercise lecture 1 starts (deadline 12:15)
- Please, answer in English
- How to submit
 - Submit to the mailbox located in the corridor of 2nd floor near the G-wing - *preferred*
 - Bring your answers to the exercise class
 - Send email to the assistant. Only emails with the subject "Exercise X", where X is the exercise number, are accepted.

What is routing?

Routing

= a process of directing the user traffic from source to destination so that the user's service requirements are met and the constraints set by the network are taken into account.

Objectives of routing:

- maximization of network performance or throughput and minimization of the cost of the network
- optimization criteria may be amount of carried traffic (blocking probability), bandwidth, delay, jitter, reliability (loss), hop count, price.
- administrative or *policy* constraints and technical reasons may limit the selection.

Optimization criteria for routing

- Additive (summing of link measures results a path measure)
 - Delay, hop count,
- Concave
 - E.g bandwidth: available bandwidth on a path is the min of bandwidths on the links of the path
 - Typically we are looking for $\text{Max}_{\text{All paths}} \{ \min_{\text{A path}} \{ \text{links} \} \}$
- Multiplicative metric: reliability, loss

The 1st key function of routing is collection of network state information and information about the user traffic

- User service requirements
- Location of the users
- Description of network resources and use policies
- Predicted or measured amount of traffic or resource usage levels

This information is used in route calculation and Selection

Some of this information is a priori known or static some is dynamic and collected on-line as needed.

Core function of routing is the generation and selection of feasible or optimal routes

- *A feasible route* satisfies the service requirements and constraints set by the user and the network
- *An optimal route* is the best based on one or many optimization criteria
- Depending on the routing algorithm may require heavy processing. If many criteria are used, the algorithm often becomes NP-complete – i.e. not usable in practical networks.

The 3rd key function is forwarding the traffic onto the selected route

- Connection oriented traffic
 - Before traffic can start to flow, a connection needs to be established (switched)
- Connectionless traffic
 - The user traffic itself carries info about the route, or an indication how to select the route
 - Packet forwarding in a router

Routing process

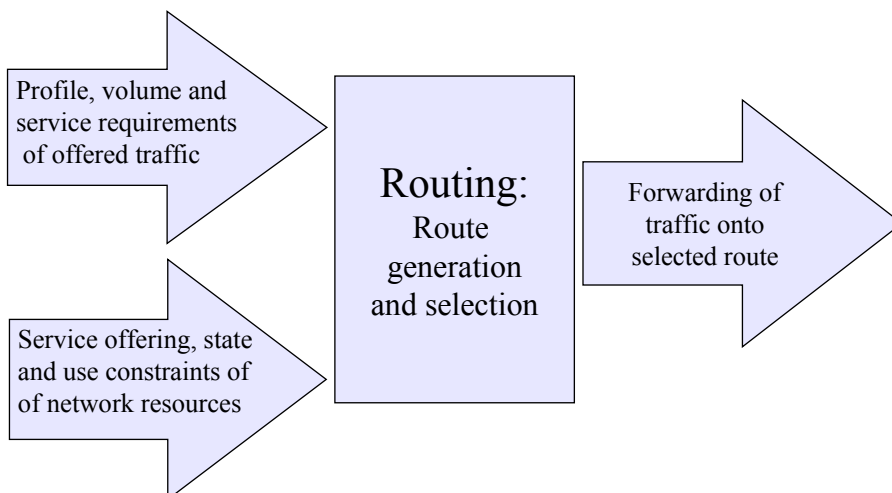

When is routing optimal?

From the user
point of view:

- Minimum probability of blocking, delay, jitter, loss or maximum bandwidth ...

Network point of
view:

- Maximum network throughput. Requires short routes, while excess traffic needs to be directed to least loaded parts of the network. At the same time user service requirements need to be met.

It follows that routing is a complex optimization problem. Most times the optimum cannot be found in a closed form. Therefore, we are interested in near-optimal, heuristic approximations.

Routing is slower than switching as a mechanism of matching traffic to network resources

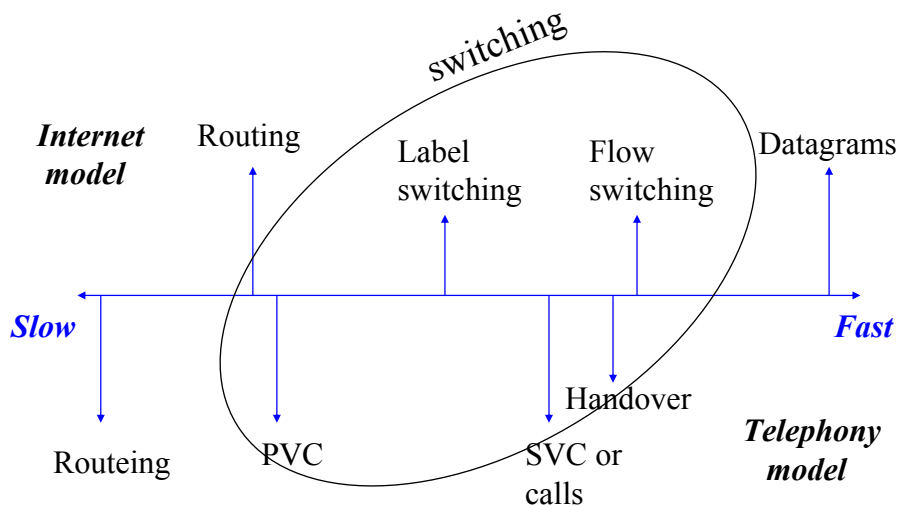

Services and service architectures rely on different resource management models

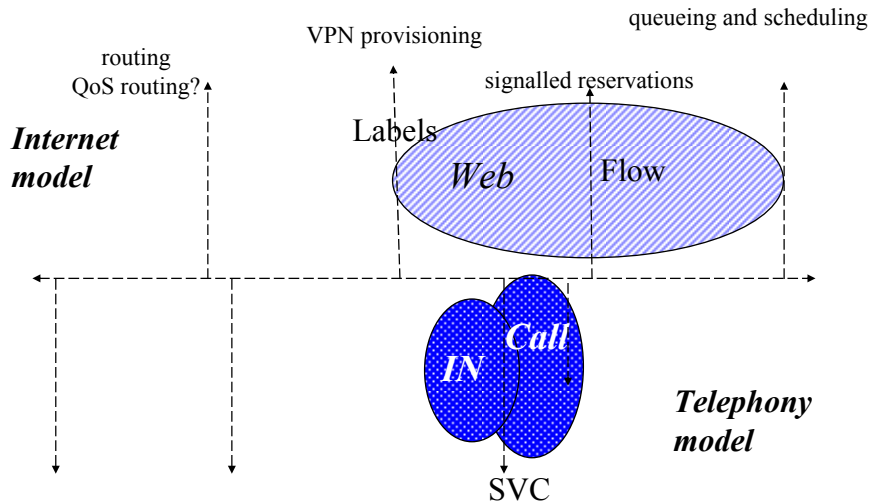

S-38.2121 / RKa, NB / Fall-2007

1-17

Each of the three key functions of routing can be either centralized or distributed

Centralized

- Eases management and may reduce cost
- A centralized function is vulnerable
- Centralized routing reacts slowly to state changes

Distributed

- Distributed routing can be based on replication or cooperation between nodes (peer-to-peer distributed system)
- Fault tolerant
- Reacts quickly
- Scales well

S-38.2121 / RKa, NB / Fall-2007

1-18

Routing in circuit switched networks

Routing in circuit switched networks

Because a subset of functions is performed during off-line network design, we talk about routeing (*väylöitys*).

Examples of routing algorithms:

- FHR - Fixed Hierarchical Routing (*hierarkinen väylöitys*)
- AAR - Automatic Alternate Routing (*vaihtoehtoinen väylöitys*)
- DAR - Dynamic Alternative Routing (*dynaaminen vaihtoehtoinen väylöitys*)
- DNHR - Dynamic Nonhierarchical routing (*dynaaminen ei-hierarkinen väylöitys*)

Lots of country-, operator- and vendor-specific variations.

The number analysis tree in an exchange connects routing to signaling information

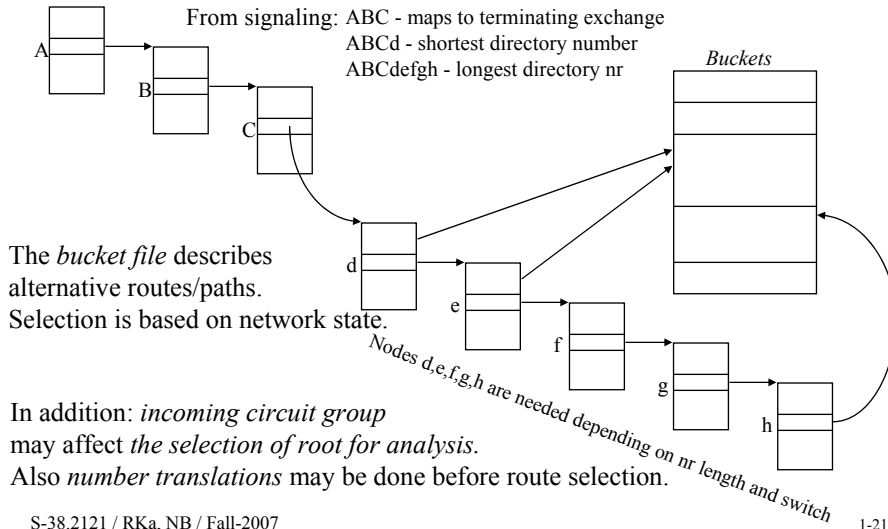

S-38.2121 / RKa, NB / Fall-2007

1-21

Number analysis tree

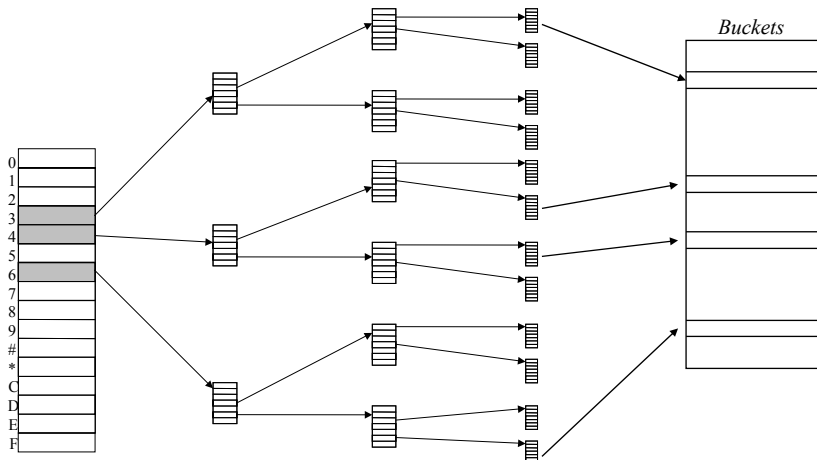

S-38.2121 / RKa, NB / Fall-2007

1-22

Properties of number analysis in PSTN exchanges

- In originating and transit **exchanges**, only the leading digits need to be analyzed. “ABC...”
- The terminating exchange needs to analyze also the rest of the digits “...defgh” to find the identity of the subscriber’s physical interface
- Numbering plan can be “open ended” (variable length numbers) or be based on fixed length numbers per area code – has implications on number analysis.

Semantics of (E.164) directory numbers

- A *directory number* points to a subscriber or a service
- A *subscriber number* is at the same time the *routing number* as well as the “logical” directory number
- Subscriber number portability breaks this 1-1 mapping
- A *service number* is always only “logical” and requires a number translation to the corresponding routing number
- It must be possible to deduce the price of the call based on the dialed digits. Therefore, the allocation of directory=routing numbers is tied to geography and network topology. Plain routing numbers are tied to network topology for convenience.

Typical properties of number analysis

- Analysis takes place between Incoming Signaling and outgoing signaling. Analysis may take as input
 - dialed digits
 - incoming circuit group, origin or subscriber category (e.g. operator)
- Analysis output may include
 - a set of alternative paths
 - translated number (e.g. for an 0800-number):
It may be necessary to repeat the analysis with the translated number as input
 - all kinds of additional information that may be needed in outgoing signaling for the call
- Analysis trees are built by the operator using MML-commands based on the routing plan. (MML=man-machine language)

Example of a route description

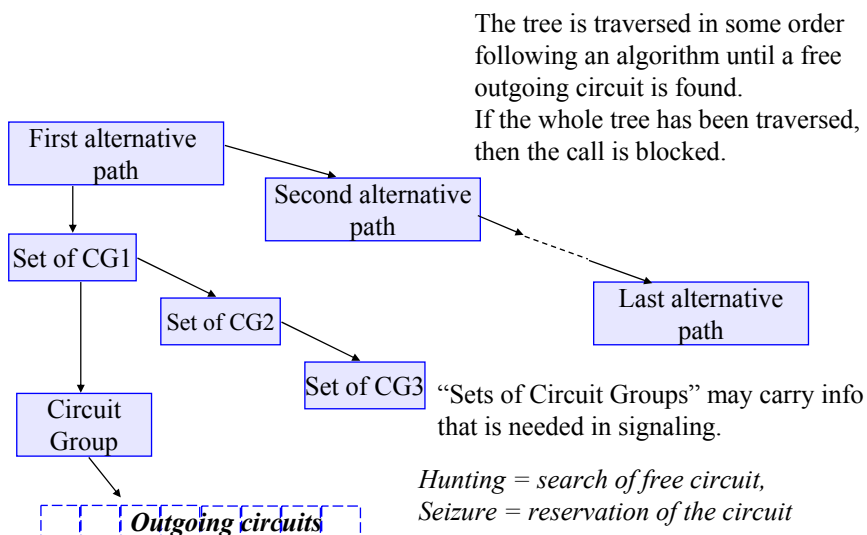

Number portability requires a number translation prior to routing

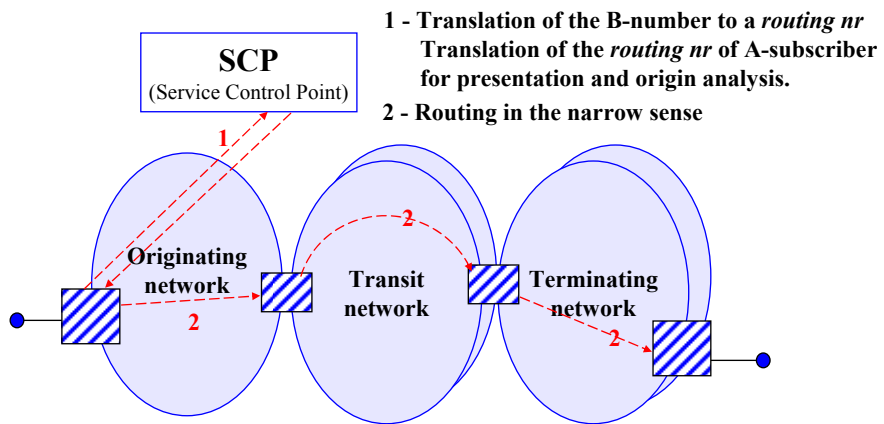

The figure present the solution to operator to operator nr portability adopted in Finland in principle.

How to do routing if one or some of the networks are based on IP?

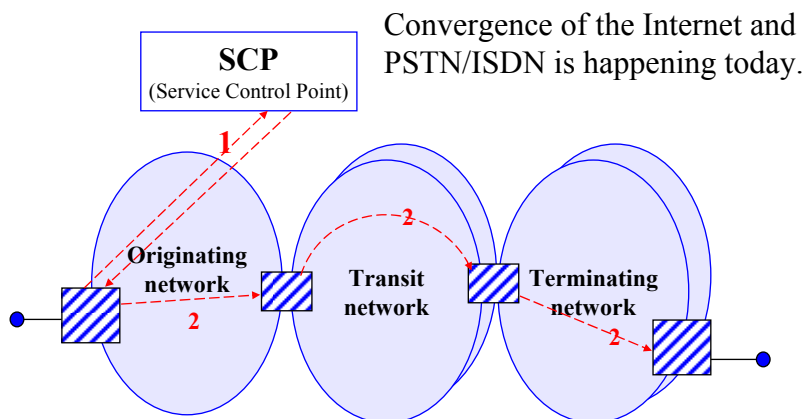

Service numbers require number translation

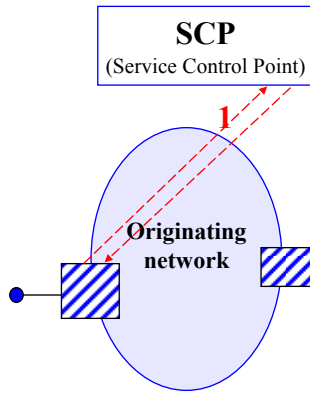

- 800-numbers, 700-numbers, 020-numbers
- Number translation can be done using IN or in an Exchange.
- Mobile numbers always require translation for a mobile terminated call
 - MS-ISDN → MSRN by HLR
- Management of number translation is easier in IN. An exchange is faster
 - (n x 100 ms vs. 1 ms).

Gateway Location is the Telephony Routing problem across a hybrid IP/Switched Circuit Network

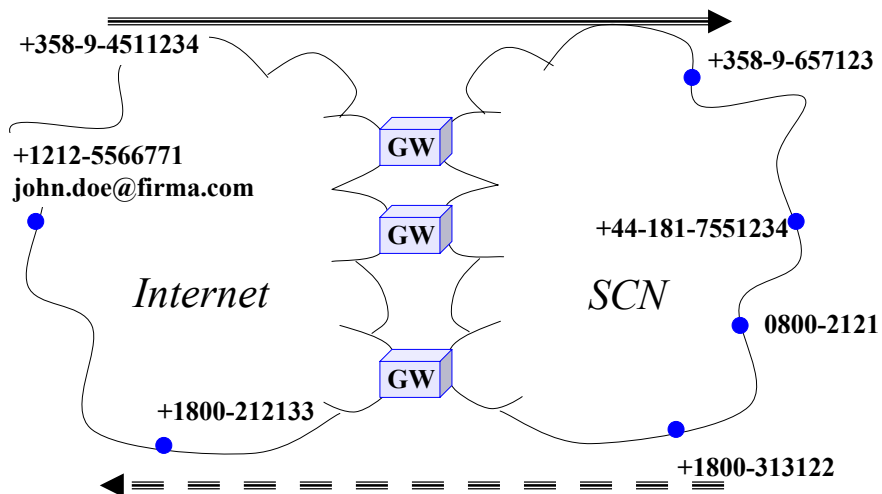

Routing in Mobile Networks

- For Mobile Terminated calls, MSISDN number needs to be translated to MSRN (mobile services routing number) that is allocated to the visiting (B-)subscriber either for the call or for the duration of the visit
- Transcoder free operation in GSM or Tandem free operation in 3G are about optimizing the path and elements on the path in such a way that media flow transcoding between codecs can be avoided

VOIP and routing alternatives

- Gateways reside in
 - telephones or at customer premises – i.e. if the destination is in the Internet use VOIP, if in PSTN use PSTN.
 - corporate PBX –networks.
 - a public network and can be accessed from any IP address.
- two first cases are trivial, last requires gateway location and AAA.

Network dimensioning and routing are dual tasks

- In *routing*, network dimensioning is given. The task is to determine how to transfer the offered traffic when network topology, link and node capacities are known.
- In *dimensioning*, the routing method and service level requirements are given. The task is to form a route plan and dimension the links (and nodes).

Offered or transferred traffic can be presented in a Traffic Matrix

- Sources and destinations can be aggregated on different levels
- Each element gives the amount of traffic over the measurement period.
- Is difficult to measure
- When the match between the matrix and the dimensioned network is far from ideal, routing may help to allocate traffic onto the network so that no bottlenecks are formed.

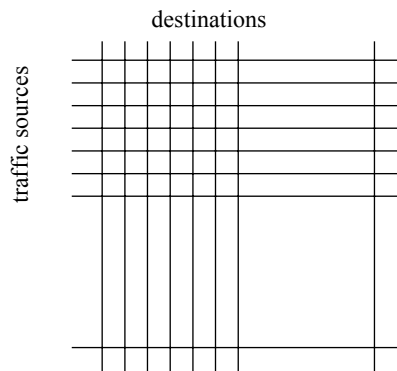

Routing systems are classified according to dynamic properties

Static routing

- Does not consider the current state of the network nor changes in traffic matrix.
- Naturally takes into account the state of individual resources.
 - It is easy to acquire info about resources close by.

Dynamic routing

- Dynamically reacts to changes in traffic load, traffic matrix and network state.
- Link and node failures.
 - It is a burden to collect info about far away nodes
- Requires continuous processing by network nodes.

Traditional routing in the PSTN (ISDN) is static

- Based on predicted traffic and a-prior knowledge of network topology and state
- Off-line network design produces the routing tables
- Is quite sufficient for example in the Finnish PSTN.

Adaptive routing can make more efficient use of network resources

- The collection of state information may be centralized or distributed
- It does not always pay off to react quickly to state changes, if the distribution of state changes takes too much time.
- Routing protocols are used in Internet.
- Newest PSTN routing systems collect information about call success/blocking events.

Dynamic predictive routing is an intermediate concept and is based on predicted traffic

- The use of the terms *static*, *dynamic*, and *adaptive* routing varies in different sources.
- Even static routing hunts and seizes circuits – i.e. adapts to local network state.
- Dynamic (predictive) routing can for example use a set of routing tables, where each table is adapted to a time interval during a day
 - E.g. in USA, DHNR improved network throughput considerably due to time difference between the east and west coasts.

The selection of route may be based on global or local information

Global information

- Efficient use of the network
- A lot of information. Real-time collection and distribution is difficult
- Vulnerable if centralized
- E.g. TINA architecture

Local information

- The solution is distributed. The nodes are autonomous.
- Scales to a network of any size.
- The goal is to find algorithms that are near optimal.

Traffic can be distributed to alternative paths

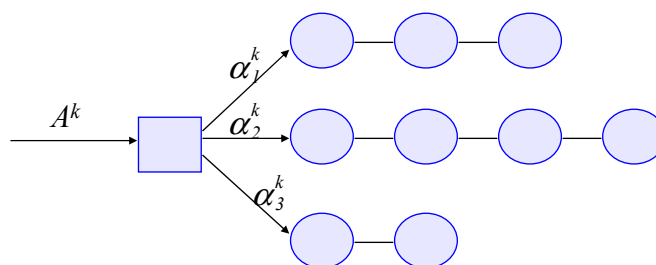

$$\sum_p \alpha_p^k = 1$$

The load balancing coefficients α_n^k can be constant or be based on measurements.

In Finland needed e.g. for load distribution between alternative transit networks. We talk about percent-routing.

percent-routing – prosenttiväylöitys

A very similar concept in the Internet is load balancing on a server bank based on DNS

Alternative routing is the basic family of routing methods in PSTN

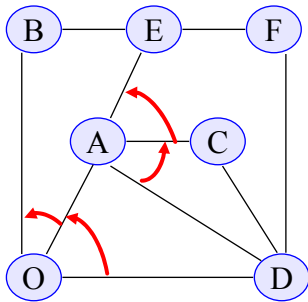

O = Origin of the call
 D = Destination of the call
 Arrows show traffic overflow or the order of selection.

All alternate paths (routes) are described in node routing tables. Design and maintenance of the tables is done off-line.

- The described alternate routes do not necessarily cover all possible routes present in the topology.
- Selection takes place using a given algorithm – the first available path is always selected.

Example: Alternate routes O - D are

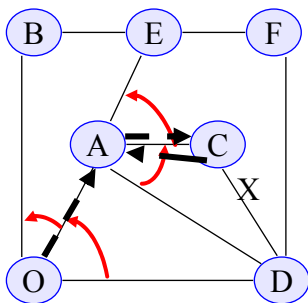

Primary: (o, d)
 Alternatives:
 (o, a, d)
 (o, a, c, d)
 (o, a, e, f, d)
 (o, b, e, f, d)

If the call has progressed to node C and there are no free circuits on (c, d)
 - The call can be either blocked, or ...
 - The call can be returned to A (*crankback*) and A may try another alternative depending on the algorithm.

Optimality can be viewed either from the point of view of the user or the network

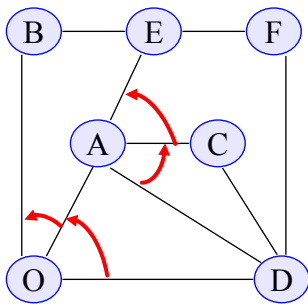

Primary: (o, d)
 Alternatives: (o, a, d)
 (o, a, c, d)
 (o, a, e, f, d)
 (o, b, e, f, d)

From the point of view of an individual call it is best to have as many alternatives as possible.

From network point of view, number of alternatives must be restricted.

E.g. (o, b, e, f, d) reserves 4 links, but (o, d) only one!

FHR – Fixed Hierarchical Routing

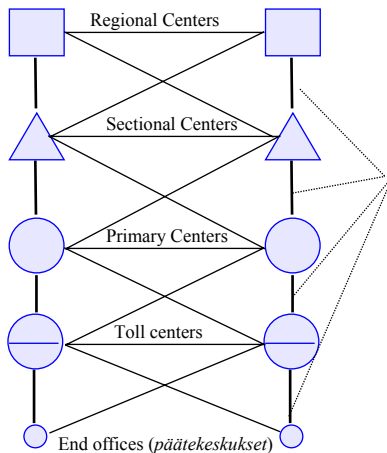

- Most traditional variant of alternate routing in PSTN
- Hierarchical levels are connected by a *final trunk group* (FTG) (*viimeinen vaihtoehtoinen yhdysjohtoryhmä*)
- *Hierarchical distance* = number of trunk groups between the exchanges

FHR routing algorithm

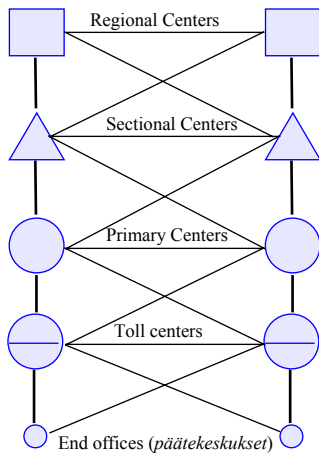

1. Path selection is based only on leading dialled digits (terminating end office). The origin of the call has no effect.
 2. A node always selects the first available circuit group for an offered call among the alternatives.
 3. Alternative paths are ordered according to ascending hierarchical distance measured from the current node to the terminating node.
 4. Last alternative path always uses the final trunk group. If there are no free circuits on the FTG, the call is blocked.
- In different networks, variants of these basic principles can be used.

Properties of Fixed Hierarchical Routing

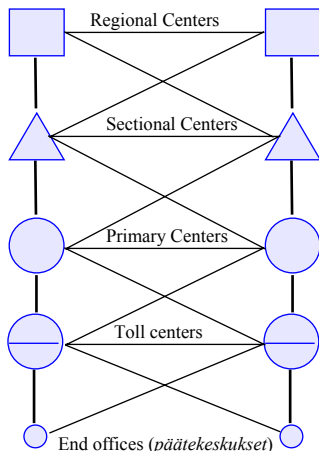

- Sets minimal requirements for the nodes
- Loops (call circulating in a loop) are not possible.
- Divides nodes into *end offices* and *transit nodes*. From the point of view of digital exchange technology, transit capability is almost a subset of end office capability.
- Can be shown to rather far from optimal in terms of network resource usage.

DNHR – Dynamic Nonhierarchical Routing

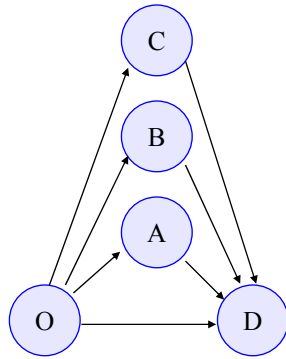

- AT&T transit network, mid-1980's – early 1990's
- All exchanges are equal – there is no hierarchy.
- A circuit group can be final for some call and non-final for another.
- Length of alternative paths is 2 hops, because long alternative routes are problematic under overload in the network.
- Uses a series of routing tables, one is selected based on the time of the day.
- DNHR uses crankback.
- E.g. O- New York, D – Miami, A- Chicago, B – LA, C – San Francisco
- Generation and optimization of routing tables requires centralized traffic data collection
 - Network Management

The *route tree* describes the routing method

Network example:

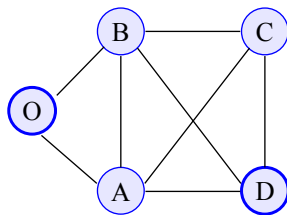

Routing tree for calls from O to D:

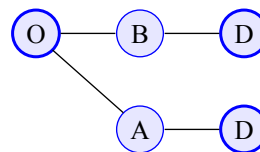

Other routes are possible, but the route planning engineer has decided not to use them

- The tree is traversed from the top to the bottom
 - Gives order of overflow
- In this example overflow control remains in O
 - OOC – *Originating Office Control (lähtökeskusohjaus)*

Overflow control can move

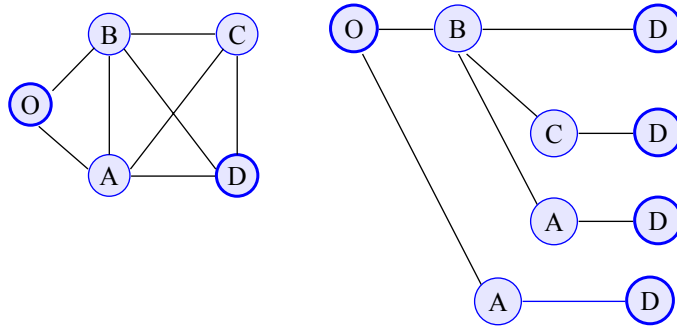

- Overflow control moves to B, if circuit (o,b) is available.
- If outgoing circuits in B are all reserved:
 - blocking if there is no crankback
 - crankback returns the overflow control back to O

In Sequential Office Control (SOC), overflow control always moves

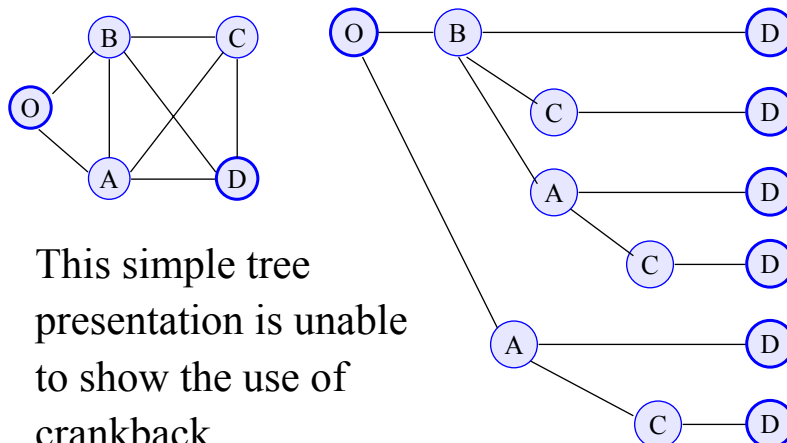

This simple tree presentation is unable to show the use of crankback.

An augmented tree with loss nodes defines the routing method

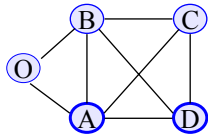

NB: Link capacity to loss node is infinite.

All alternative routing methods can be described using such augmented route trees.

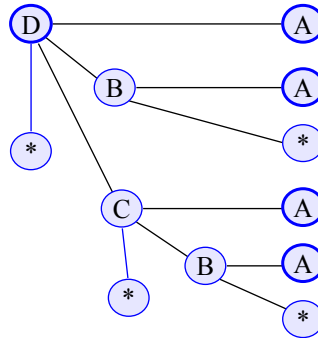
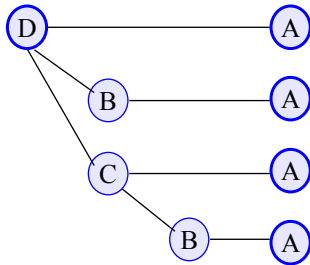

Influence graph shows the presence or absence of routing loops

- If routing is based on SOC and alternative paths are longer than 2 hops, loops are possible.
- Mutual overflow (from link A to link B and from B to A) *may* also be undesirable.
- Influence graph can also define and analyze a partial order in a network.

Route tree with a loop

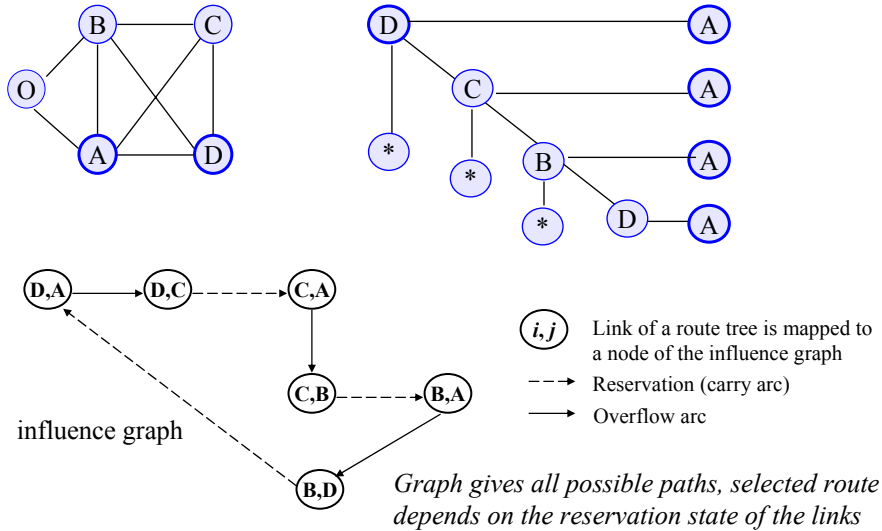

S-38.2121 / RKa, NB / Fall-2007

1-53

Influence graph can be presented in an algebraic form

$\sigma(i, j)$ – For trunk group i , and calls destined for j , indicates number of the trunk group to which a blocked call will overflow.

$\rho(i, j)$ – For trunk group i , and calls destined for j , indicates number of the trunk group to which calls that are carried on i will be offered.

- Existence of a loop in the influence graph is equivalent with the existence of a routing loop in the network design.
- Lots of well known standard algorithms for graphs exist
 - Loops are easy to find.

S-38.2121 / RKa, NB / Fall-2007

1-54

Mutual overflows are revealed by superposition of influence graphs

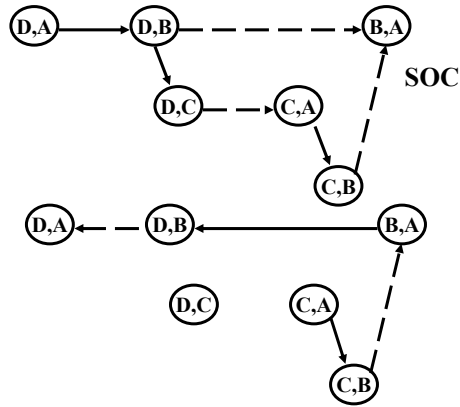
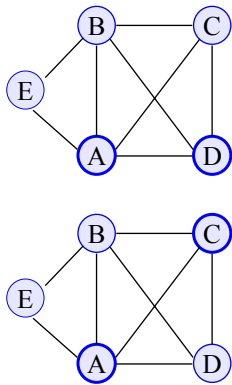

If there are no loops, a partial order exists in the network. Dimensioning and modelling of the routing are simplified in case a partial order exists.

Adaptive routing

- Computer controlled exchanges can use a more varied set of input data for route calculation than just dialed digits.
- Alternate Routing allocates traffic to a small set of alternative paths in a predetermined order.
- Adaptive routing allocates traffic to a possible large set of alternative paths without a pre-determined order.
- Value function is calculated for the alternatives determining the selection of the path among all alternatives. The value function may keep state (=history of previous calls).
- Variations are based on the type of the value function, way of collecting input data for the value function etc.

DAR – Dynamic Alternative Routing (1)

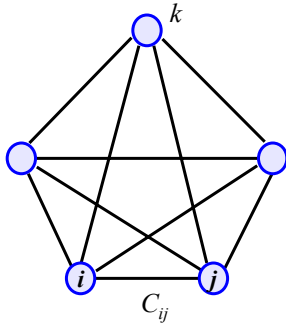

DAR works in a full mesh network

Paths directly from node i to node j and alternate paths of max two hops are allowed.

r_{ij} - **link reservation parameter** of link i,j .

$k(i,j)$ - **current alternate tandem node** for traffic from node i to node j on the alternate path

A call from node i to node j is always offered first to the direct link and is carried on it if a circuit is available. Otherwise, the call is offered to the two hop alternate path through node k . The call succeeds, if r_{ik} and r_{kj} circuits are free. If not, the call is blocked and a new k is selected,

DAR – Dynamic Alternative Routing (2)

- A call using a two hop alternative path can cause blocking of many subsequent calls if it is allowed to reserve the last circuit.
- Without the link reservation parameter, r_{ij} , the state of the network is unstable (or bistable) – the amount of max through-connected traffic alternates between two levels – the network oscillates.
- E.g. N nodes, $N(N-1)$ links, each have M circuits. Each node originates p calls.

$$\begin{aligned} \text{If calls use only direct links} &\Rightarrow p N \leq N(N-1) M \\ &\Rightarrow p \leq (N-1) M \end{aligned}$$

If all calls use 2 circuits \Rightarrow

$$\text{Total is } 2pN \text{ circuits} \leq N(N-1) M \Rightarrow p \leq (N-1) M/2$$

DAR – Dynamic Alternative Routing (3)

- Even on high capacity links r is a small value.
- It is even sufficient that $r \neq 0$ is defined only for the first link on the alternative paths.
- If one call is allowed to try more than one alternative two hop path, the value of r must be increased.

DAR variants

- Current tandem node is switched when the last allowed circuit is reserved on the alternative path.
- Some alternative nodes may be better than others → the selection of a new tandem node can be weighted to favor good nodes instead of being just random.
- If a lot of traffic is carried on the alternative route, it can be distributed to several current alternative paths each of which is switched independently.

BT implementation of DAR (1)

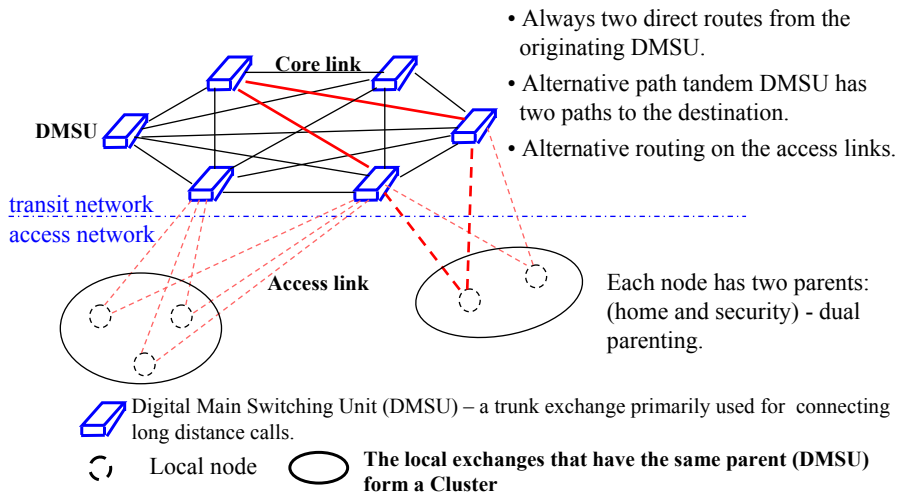

- Always two direct routes from the originating DMSU.
- Alternative path tandem DMSU has two paths to the destination.
- Alternative routing on the access links.

S-38.2121 / RKa, NB / Fall-2007

1-61

BT implementation of DAR (2)

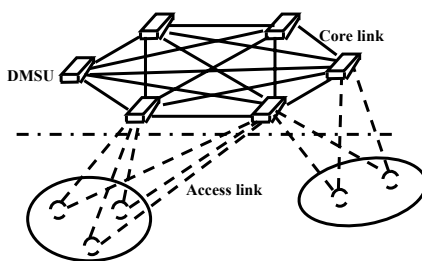

BT has more than 60 DMSU's.

Possibilities:

- Incoming and outgoing traffic on Access links can go primarily thru different parents.
- Extension of the Scenario to multi-parent network.
- Nrof parents per access node can vary.
- Nrof alternative tandem nodes is $N - 3$.

Last Chance priority

- Incoming traffic that has reached the destination parent has only one chance to succeed.
- Therefore, it makes sense to define a trunk reservation parameter for Access links so that outgoing traffic is not allowed to reserve the last circuit on the primary access link for terminating traffic.

S-38.2121 / RKa, NB / Fall-2007

1-62

Adaptive routing in a (international) partial mesh network

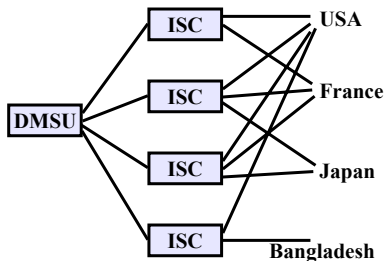

ISC – International Switching Center

Alternatives:

- ISC-to-country link reservation status is passed to DMSU which offers outgoing traffic to least loaded ISC – needs additional signaling.
- Proportionate routing (kuormanjako) – needs reliable predictions of traffic
- Crankback from ISC if int-links reserved – in overload the processing load in nodes grows quickly: call is transferred back and forth from one ISC to another + Additional capacity from DMSU to ISC can degrade the overall performance.
- DAR with fixed primary-ISC – problem is how to allocate the primary roles to ISC's.
- *DAR to one primary ISC, switch to alternative ISC if a call is blocked – one call has only one chance to succeed. This turns out to be the best algorithm!*

S-38.2121 / RKa, NB / Fall-2007

1-63

Comparison of DAR variants

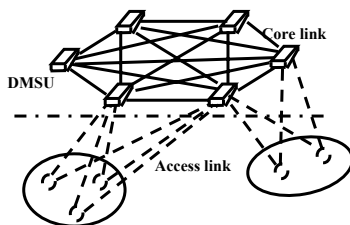

Alternative algorithms:

1. Outgoing traffic always offered to parent i and terminating traffic to parent j . In the full mesh transit network direct and all two alternative paths are allowed (single parenting) - high blocking probability.
2. All four direct routes are allowed, least loaded is chosen (LLR-least loaded routing).
NB: This requires distribution of the reservation state information! Performance approaches to theoretical optimum.
3. We are interested in finding a method with performance approaching to LLR, but such that it is easy to implement
⇒ sticky principle and last chance priority.

S-38.2121 / RKa, NB / Fall-2007

1-64

Sticky principle retains a path if a call succeeds and skips the path if blocking occurs

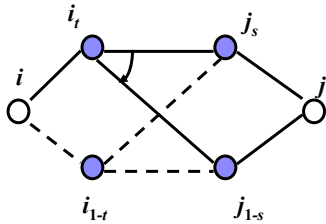

1. Primary parent of node i towards j is i_t
2. Primary destination parent of tandem i_t towards j is j_s
3. If call succeeds thru $i_t j_s$, primary roles are retained.
4. If blocking occurs thru $i_t j_s$, call is offered to $i_t j_{1-s}$, if success, i_t adopts j_{1-s} as the primary choice towards j .
5. If 4 fails, call is blocked and i adopts i_{1-t} as the primary choice towards j .

General sticky principle combines sticky learning with last chance priority

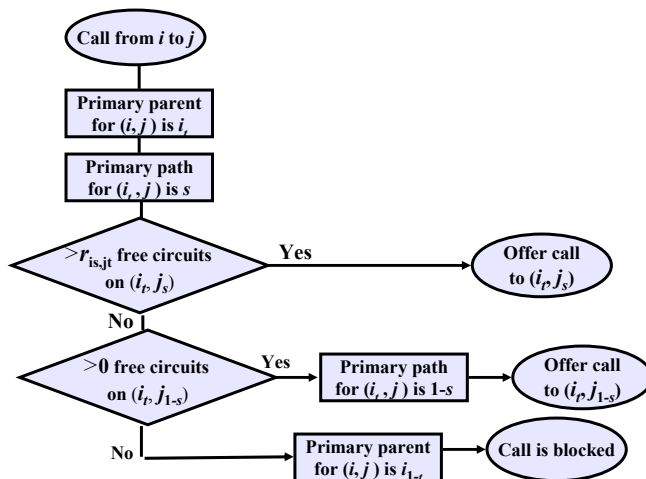

RCAR - Residual Capacity Adaptive Routing is used in Canada

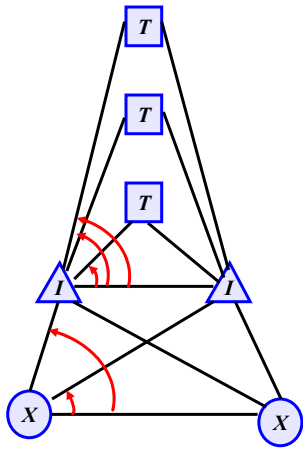

- Implementation name: DCR – dynamic call routing/Telecom Canada
- Info about outgoing circuit reservation status, number of blocked calls and CPU load is collected each 10s to a centralized network management center. The center calculates and downloads new routing tables for I and T switching nodes.
- The idea is to choose the path with most free circuits.
- Improves network performance significantly.
- Adapts quickly to unusual traffic patters and to link and node failures.
- Benefits relate to time difference between coasts.
- Vulnerable to failure of management center. Falls back to FHR model, if the center stops.

Summary of routing in SCN

- Static routing is most common in PSTN
- Alternative routing is easy since route pin-down is natural: existing calls stay on their original route when fresh call attempts are placed on an alternative path – this is different from the Internet in which a change in routing immediately affects all packets towards the destination
- Dynamic routing with local information often achieves as low blocking as least loaded routing that needs global knowledge.
 - may require careful tuning to achieve stability
- Dynamic Non-hierarchical routing in AT&T's network led to the invention of TMN – Telecommunications Management Network
- We have learned methods to describe the routing algorithm in an SCN accurately.