

Link State Routing Principles

Link state routing

- The goal is to avoid the routing loops typical of DV routing and to scale to bigger networks and to varying topologies.
- A link state protocol maintains the topology map, i.e. [the link state database](#) of the network.
 - Same map in every node
 - When the topology changes, the maps are updated quickly
- [OSPF \(Open Shortest Path First\)](#) is the IETF specified link state protocol for Internet.
 - OSPF is recommended as the follower of RIP
 - More complex than RIP

The map is the complete list of all links

- Example network

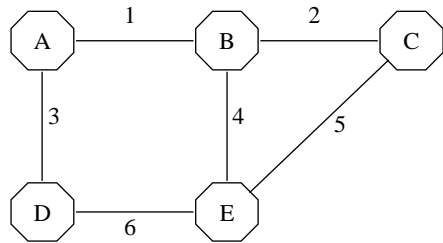

Link state database:

From	To	Link	Cost
A	B	1	1
A	D	3	1
B	A	1	1
B	C	2	1
B	E	4	1
C	B	2	1
C	E	5	1
D	A	3	1
D	E	6	1
E	B	4	1
E	C	5	1
E	D	6	1

- One node is responsible for a particular entry
- Link directions are separate entries
- Same map in every node
 - No loops

The routing table is generated from the link state database

From	To	Link	Cost
A	B	1	1
A	D	3	1
B	A	1	1
B	C	2	1
B	E	4	1
C	B	2	1
C	E	5	1
D	A	3	1
D	E	6	1
E	B	4	1
E	C	5	1
E	D	6	1



From	To	Link	Cost
A	A	local	0
A	B	1	1
A	C	1	2
A	D	3	1
A	E	3	2

Routing table of node A

Link state database

The flooding protocol distributes information about topology changes

- The updates, “link state advertisements”, are distributed to the whole network

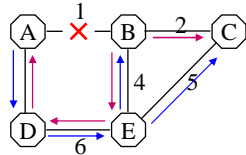

From	To	Link	Cost	Seq.num
A	B	1	inf	2

From	To	Link	Cost	Seq.num
B	A	1	inf	2

Sequence number indicates that the updated entry is newer

Flooding algorithm

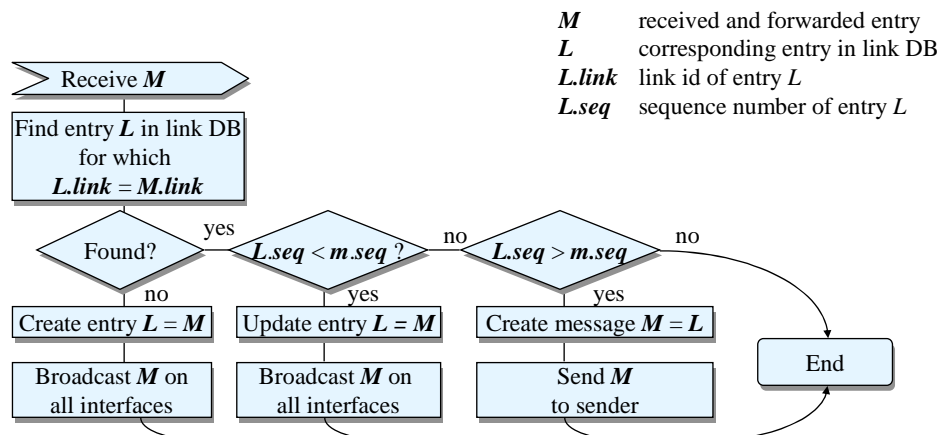

Link database after distribution of failure of link AB

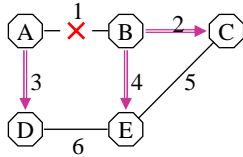

From	To	Link	Cost	Seq.num
A	B	1	inf	2
A	D	3	1	1
B	A	1	inf	2
B	C	2	1	1
B	E	4	1	1
C	B	2	1	1
C	E	5	1	1
D	A	3	1	1
D	E	6	1	1
E	B	4	1	1
E	C	5	1	1
E	D	6	1	1

- Sequence number starts from 1 on node restart.
- Modulo arithmetic is used to determine what is “a little bigger than”
 - ⇒ message numbering can overflow without problems.
 - ⇒ $4294967295 + 1 = 0$
- OSPF uses a slightly different numbering, as will be discussed later.

S-38.2121 / Fall-07 / RKa, NB

LS-7

If network splits into islands, databases in islands may diverge

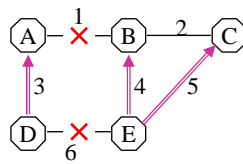

From	To	Link	Cost	Seq.num
A	B	1	inf	2
A	D	3	1	1
B	A	1	inf	2
B	C	2	1	1
B	E	4	1	1
C	B	2	1	1
C	E	5	1	1
D	A	3	1	1
D	E	6	inf	2
E	B	4	1	1
E	C	5	1	1
E	D	6	1	1

From	To	Link	Cost	Seq.num
A	B	1	inf	2
A	D	3	1	1
B	A	1	inf	2
B	C	2	1	1
B	E	4	1	1
C	B	2	1	1
C	E	5	1	1
D	A	3	1	1
D	E	6	1	1
E	B	4	1	1
E	C	5	1	1
E	D	6	inf	2

S-38.2121 / Fall-07 / RKa, NB

LS-8

Link 2 fails \Rightarrow databases diverge even more

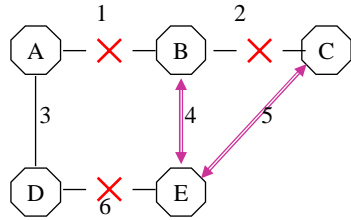

Databases in B, C and E:

From	To	Link	Cost	Seq.num.
A	B	1	inf	2
A	D	3	1	1
B	A	1	inf	2
B	C	2	inf	2
B	E	4	1	1
C	B	2	inf	2
C	E	5	1	1
D	A	3	1	1
D	E	6	1	1
E	B	4	1	1
E	C	5	1	1
E	D	6	inf	2

When link 1 goes up, the databases must be combined

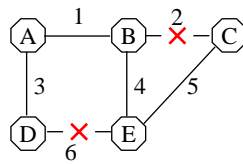

From	To	Link	Cost	Seq.num.
A	B	1	1	3
A	D	3	1	1
B	A	1	1	3
B	C	2	1	1
B	E	4	1	1
C	B	2	1	1
C	E	5	1	1
D	A	3	1	1
D	E	6	inf	2
E	B	4	1	1
E	C	5	1	1
E	D	6	1	1



From	To	Link	Cost	Seq.num.
A	B	1	1	3
A	D	3	1	1
B	A	1	1	3
B	C	2	inf	2
B	E	4	1	1
C	B	2	inf	2
C	E	5	1	1
D	A	3	1	1
D	E	6	1	1
E	B	4	1	1
E	C	5	1	1
E	D	6	inf	2



From	To	Link	Cost	Seq.num.
A	B	1	1	3
A	D	3	1	1
B	A	1	1	3
B	C	2	inf	2
B	E	4	1	1
C	B	2	inf	2
C	E	5	1	1
D	A	3	1	1
D	E	6	inf	2
E	B	4	1	1
E	C	5	1	1
E	D	6	inf	2

After reconnection of the islands “bringing up adjacencies” is required

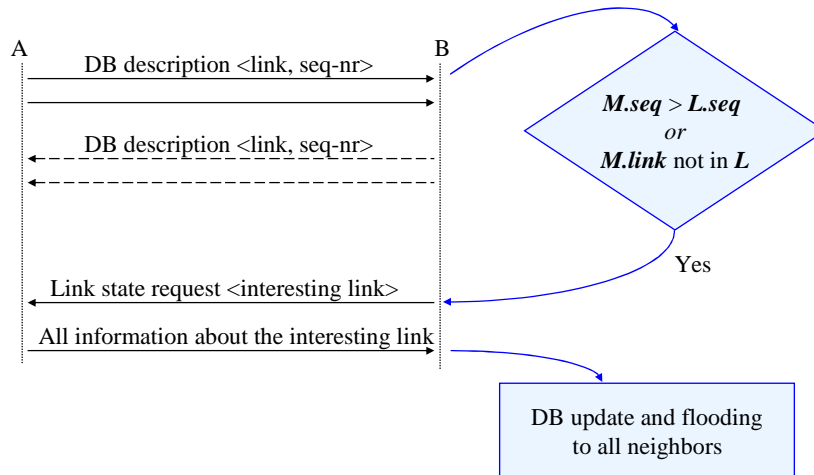

S-38.2121 / Fall-07 / RKa, NB

LS-12

What happens if router A is restarted?

- There may be LSAs in the network that were distributed by A before the restart
 - After the restart, the router numbers the LSA:s with the initial sequence number
 - The neighbor B replies that it has newer information.
 - If A wants to keep its own LSAs alive, it increases the sequence number by 1 and redistributes.
 - If the information of the neighbor is no longer valid, A removes it by distributing the same entry with the age = MaxAge.

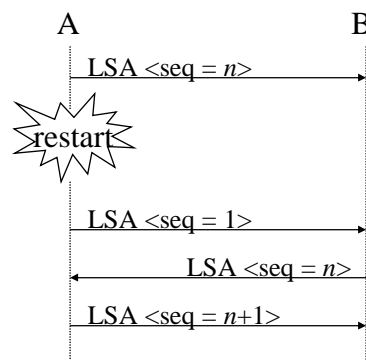

S-38.2121 / Fall-07 / RKa, NB

LS-13

Integrity of the link DB must be secured

Protection:

- Flooding messages are acknowledged link by link.
- DB description messages are acknowledged.
- Each DB entry is protected by obsolescence timer. If an update does not arrive in time, the entry is removed.
- Each entry is protected by a checksum.
- Messages also carry authentication info.

But: while update is in progress, some nodes receive info earlier than others \Rightarrow routing mistakes happen.

Dijkstra's shortest-path-first algorithm

OSPF is based on Dijkstra's shortest-path-first algorithm

- Purpose: create a routing table from the link-state database.
- The algorithm computes the shortest path from source node S to all the other nodes.
- Dijkstra's algorithm converges faster than Bellman-Ford.
 - $O(M \log M) < O(MN^2)$ (centralized B-F)
 - $O(M \log M) < O(MN)$ (distributed B-F)
 - M is number of links, N is number of nodes,
 - both the of same order of magnitude
- Nodes are divided into
 - evaluated nodes E , the paths from which are known, and
 - other nodes R .
- In addition an ordered list of paths O is needed.

Dijkstra's shortest-path-first algorithm

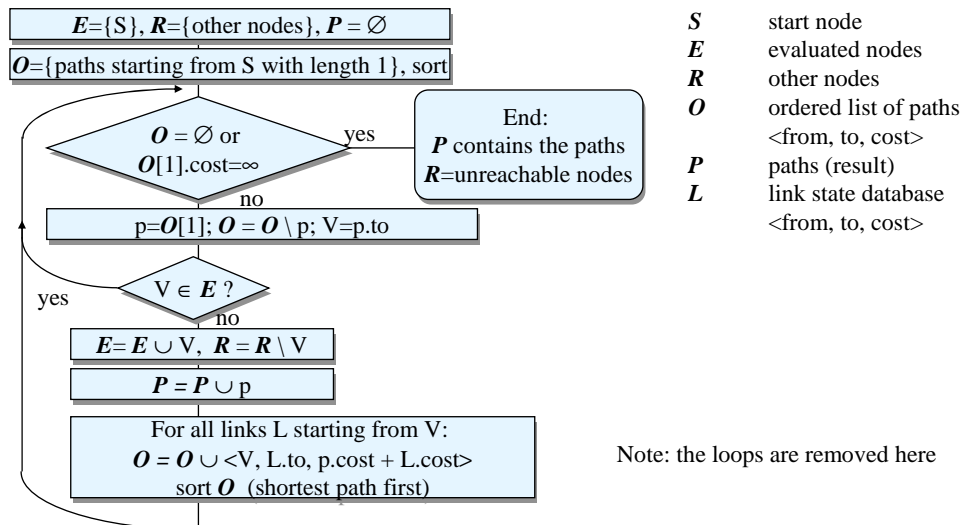

Dijkstra's shortest-path-first algorithm

1. $E=\{S\}$, $R=\{N-S\}$, $O=\{\text{all one-hop paths starting from } S\}$
2. If O is empty or is the first path in O has infinite length:
 - then mark all the remaining nodes in R as unreachable
 - and stop
3. P is the first (=shortest) path in O . Remove P from O . V is the last node of P .
4. Is V is in E ?
 - then go to step 2
5. Create a set of paths by adding to P all links starting from V . The length is the length cost + the cost of the link. Add these paths to O in length order. Move V from R to E .
6. Go to step 2

Dijkstra's shortest-path-first algorithm – example

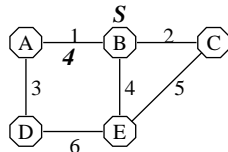

L

From	To	Link	Cost
A	B	1	4
A	D	3	1
B	A	1	4
B	C	2	1
B	E	4	1
C	B	2	1
C	E	5	1
D	A	3	1
D	E	6	1
E	B	4	1
E	C	5	1
E	D	6	1

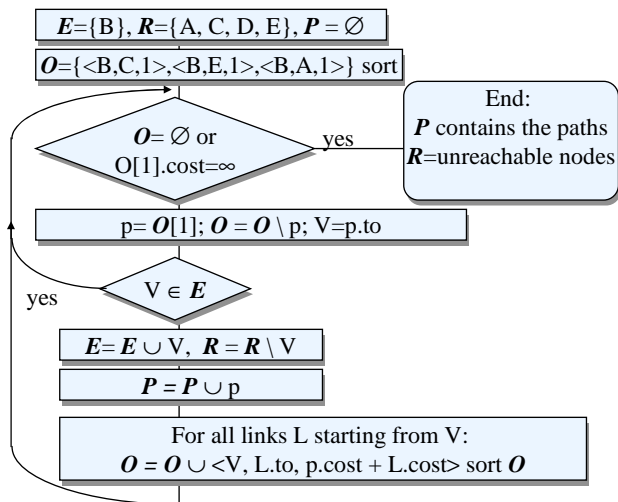

Dijkstra's shortest-path-first algorithm – example

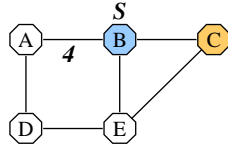

E
B
R
A, C, D, E
O
<B,C,1>
<B,E,1>
<B,A,4>

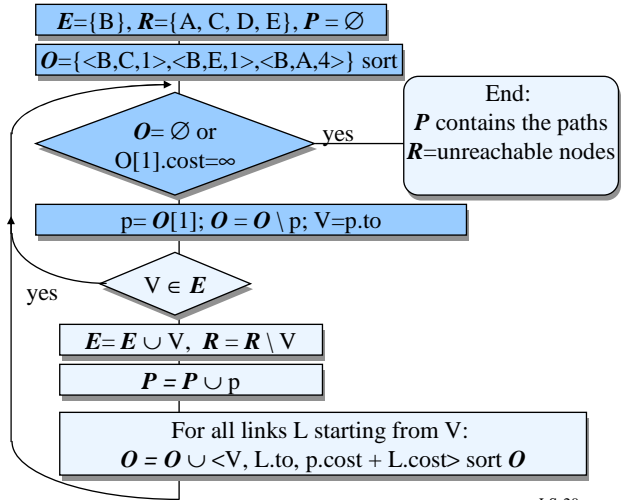

Dijkstra's shortest-path-first algorithm – example

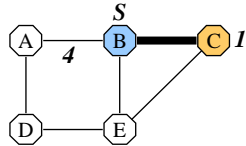

E
B, C
R
A, D, E
O
<B,E,1>
<C,E,2>
<B,A,4>

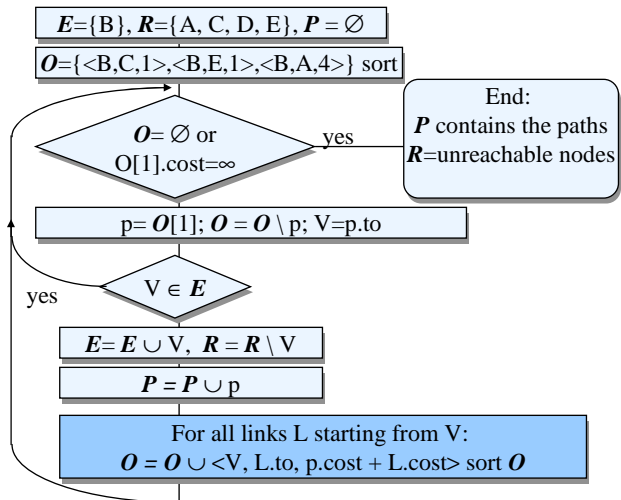

Dijkstra's shortest-path-first algorithm – example

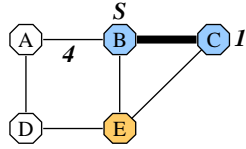

E
B, C
R
A, D, E
O
<B,E,1>
<C,E,2>
<B,A,4>

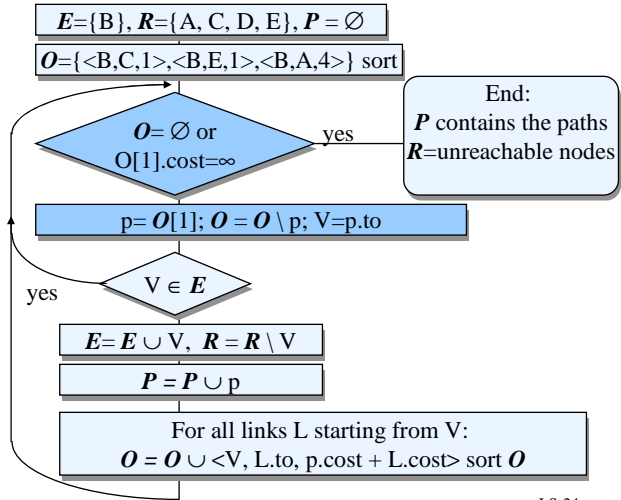

Dijkstra's shortest-path-first algorithm – example

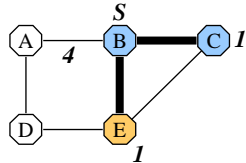

E
B, C, E
R
A, D
O
<C,E,2>
<B,A,4>

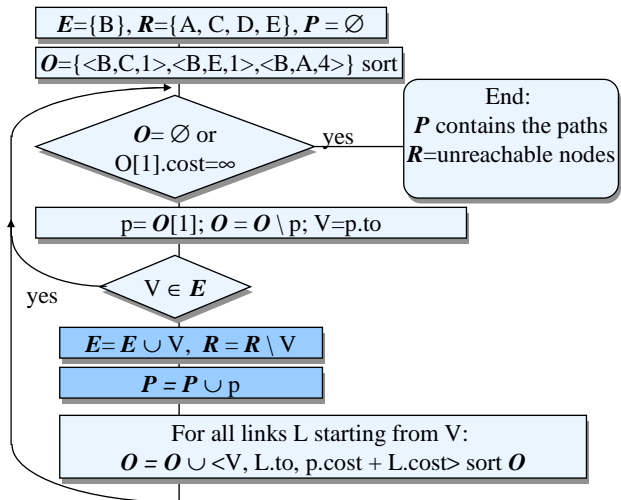

Dijkstra's shortest-path-first algorithm – example

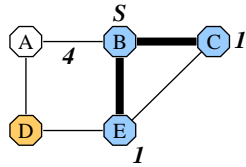

E
B, C, E
R
A, D
O
<E,D,2>
<B,A,4>

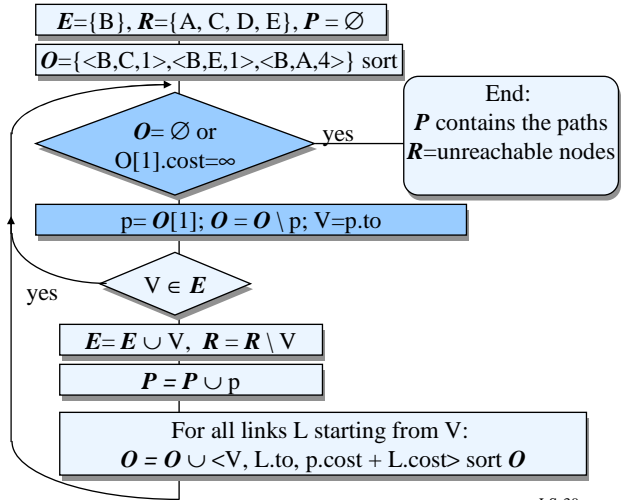

Dijkstra's shortest-path-first algorithm – example

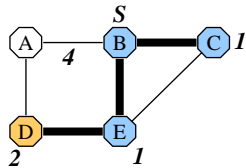

E
B, C, E, D
R
A
O
<D,A,3>
<B,A,4>

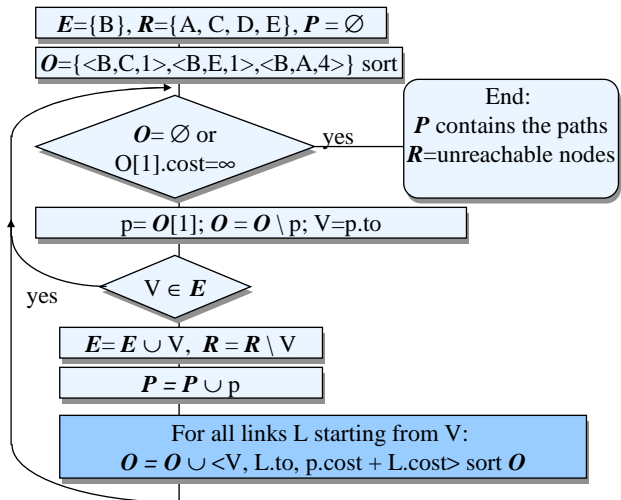

Dijkstra's shortest-path-first algorithm – example

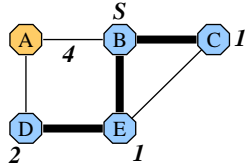

E	B, C, E, D
R	A
O	<D,A,3>
	<B,A,4>

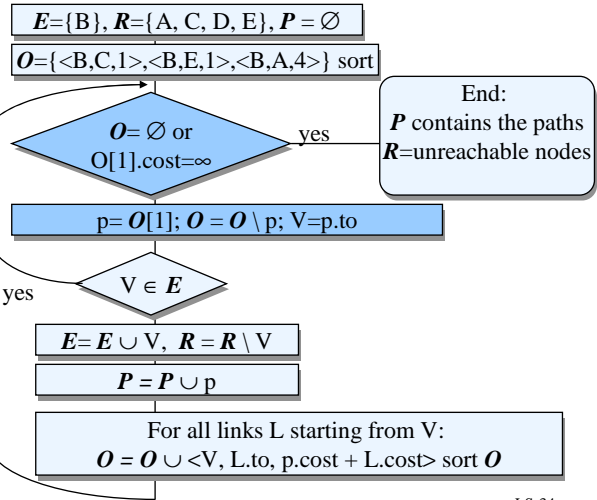

Dijkstra's shortest-path-first algorithm – example

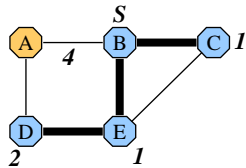

E	B, C, E, D, A
R	
O	<B,A,4>

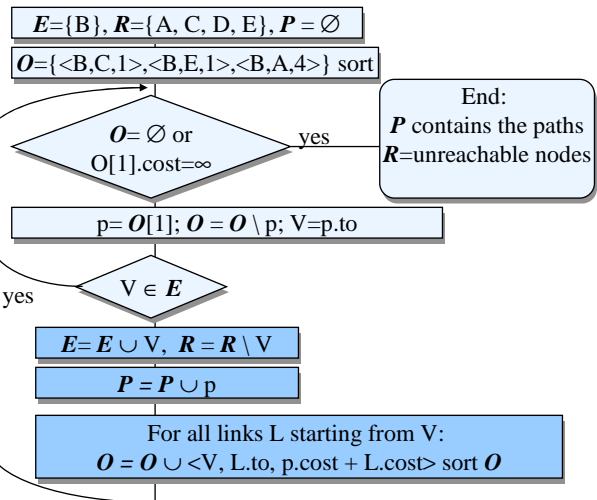

Dijkstra's shortest-path-first algorithm – example

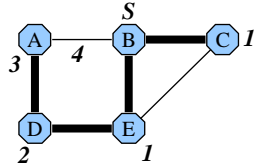

E

B, C, E, D, A

R

O

<B,A,4>

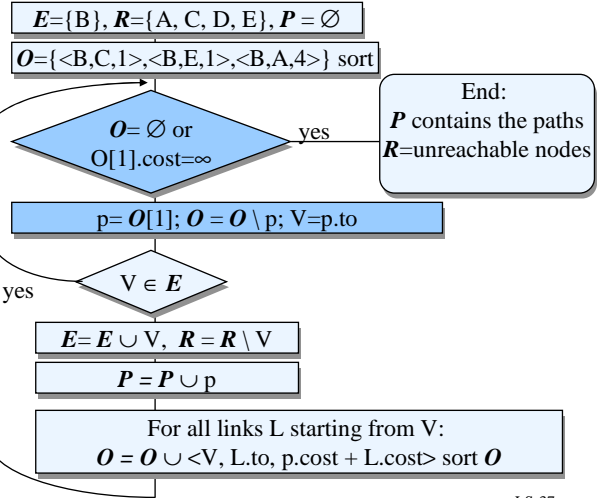

Dijkstra's shortest-path-first algorithm – example

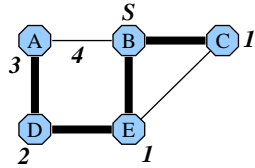

E



B, C, E, D, A

R

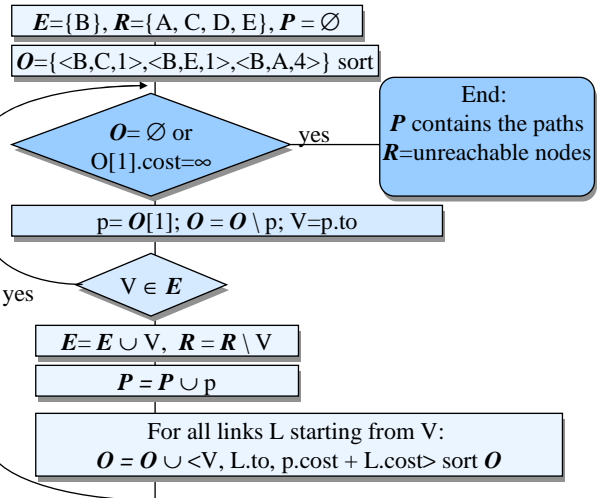
O



Advantages of Link State Protocols

- Link State DBs converge quickly, no loops are formed
 - $O(M \log M)$ $M = \text{number of links}$
- Metrics can be quite accurate.
 - In DV-protocols, counting-to-infinity limits ($\text{inf}=16$)
- One protocol can easily support several metrics: 
 - A routing table for each metric: throughput, delay, cost, reliability.
- Can maintain several routes to a destination. 
 - Load balancing
- Exterior routes can have their own representation. 

Using several metrics (1)

Using several metrics requires:

- Several metrics must be stored for each link
 - $L_{metric1}, L_{metric2}, \dots$
- The protocol must transport all metrics
- Computing separate routing tables for each metric
 - $P_{metric1}, P_{metric2}, \dots$
- User packets must be marked with the required metric.
 - Type-of-service field in IP packet header

Using several metrics (2)

A routing loop is possible if different nodes use different metrics for one user packet

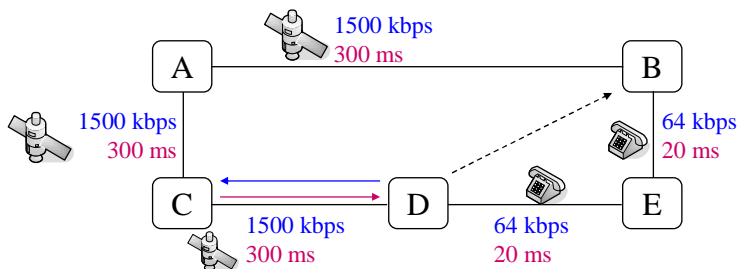

⇒ User packets must be marked with the required metric

Spreading load to alternative equidistant paths improves network efficiency

- + More bandwidth
- + Shorter queues in routers
- + Average delay is decreased
- + End-to-end jitter decreases
- + Less traffic to reroute under failure conditions
- May change packet order because paths may have different delay (different queue lengths in nodes)

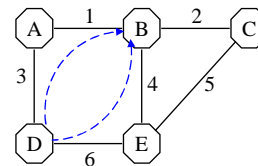

- ⇒ keep the same path for a connection (hash from address & port)
- Existing traffic can not be pinned down to primary path so that only overload would take the alternative path ⇒ stability is a problem
- ? When are paths equidistant enough?

When are paths equidistant enough?

- What happens if the traffic to C is divided between two alternative paths?

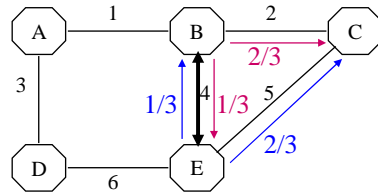

⇒ The packet to X can be sent through Y only if Y is closer to the destination than the current node

- Rule $A \rightarrow Y \dots \rightarrow X$, if $\text{distance}(Y \rightarrow X) < \text{distance}(A \rightarrow X)$ accepts only monotonic alternative routes

Dijkstra's shortest-path-first algorithm that finds alternative paths

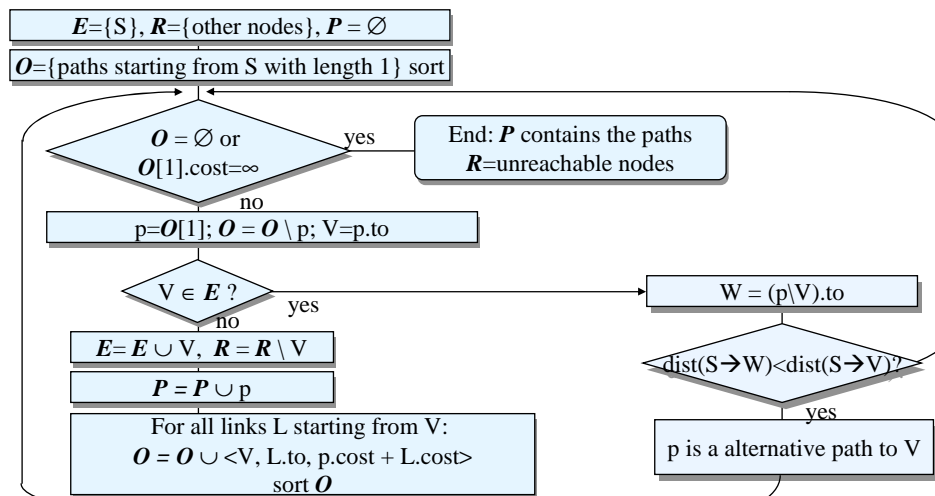

Dijkstra's shortest-path-first algorithm that finds alternative paths

1. $E=\{S\}$, $R=\{N-S\}$, $O=\{\text{all one-hop paths starting from } S\}$
2. If O is empty or is the first path in O has infinite length:
 - Mark all the remaining nodes in R as unreachable
 - Stop
3. P is the shortest path in O . Remove P from O . V is the last node of P .
4. Is V is in E :
 - Go to step 6
5. Create a set of paths by adding to P all links starting from V . The path is the previous path + the cost of the link. Add these paths to O in length order. Go to step 2.
6. If the distance of path P from S to V is the same as previously calculated distance from S to V
 - Add the alternative path to V .
7. Go to step 2

Link state protocol can describe several external routes with accurate metrics

- DV-protocol capability to describe external routes is limited due to counting to infinity problem and due to complexity of Bellman-Ford algorithm
 - $\text{Inf} = 16 \Rightarrow$ maximum distance limited
 - Bellman-Ford complexity is $O(N^2)$
- Link state protocol is free from those limitations
 - Distance is not limited
 - Dijkstra complexity is $O(N \log N)$
where $N =$ number of external routes
 - \Rightarrow E.g. complexity of 60 000 external routes (in 1999):
 $3.6 \cdot 10^8$ vs. 287 000

The OSPF protocol

OSPF sees the network as a graph

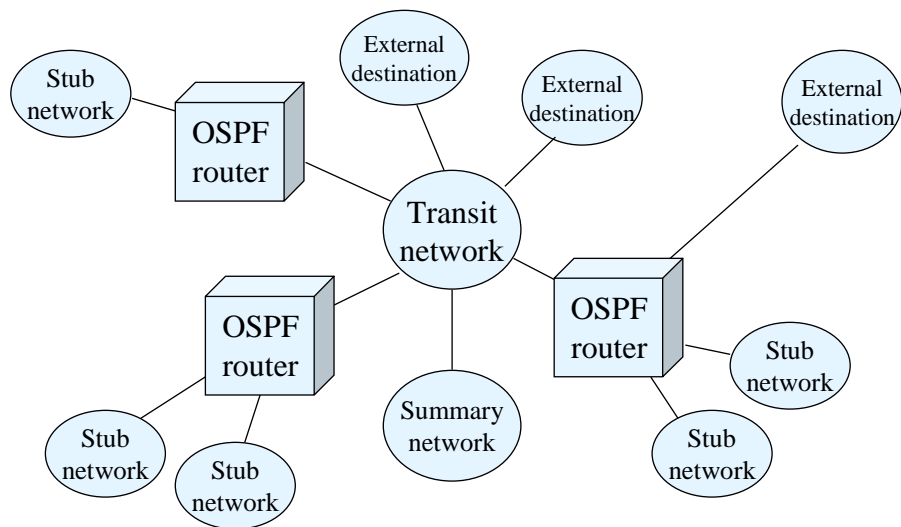

OSPF separates between a router and a host

A strict link state protocol would separately describe the link between each host and router

OSPF uses IP subnet mask and advertises only a single (sub)net

This creates two link state records:

- router
- stub network

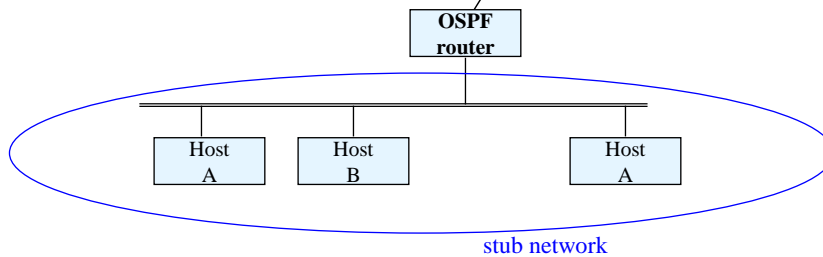

OSPF supports broadcast networks (1)

- In a broadcast network (e.g. Ethernet, Token ring, FDDI)
 - Each device can send to each other (unicast)
 - One can send to all (broadcast) or to a subset (local multicast) of connected devices
- If it has N routers, they have $N \cdot (N-1) / 2$ adjacencies
- Each router would advertise $N-1$ routes to other routers + one stub network $\Rightarrow N^2$

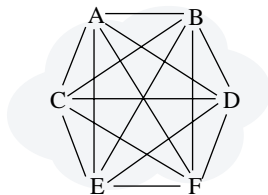

$N \cdot (N-1) / 2$ adjacencies (known neighbors)

OSPF supports broadcast networks (2)

Designated router A Backup designated router B

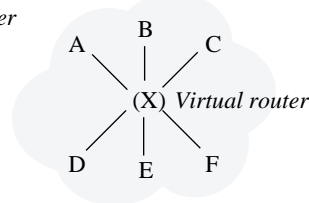
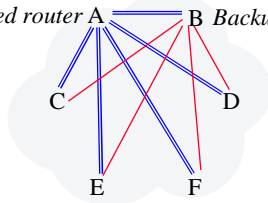

- Adjacencies are formed only with the **designated router** (A)
 - ⇒ Must be selected using the Hello protocol
 - ⇒ Synchronization of link DBs becomes simpler
- **Backup designated router** (B) is selected together with the designated.
- The broadcast network is modeled using a **virtual router**
 - The links *from* the virtual router to the routers are **network links**
 - Advertised by the designated router
 - Cost = 0
 - The links from the routers *to* the virtual router
 - Advertised by the routers

OSPF flooding protocol in a broadcast network

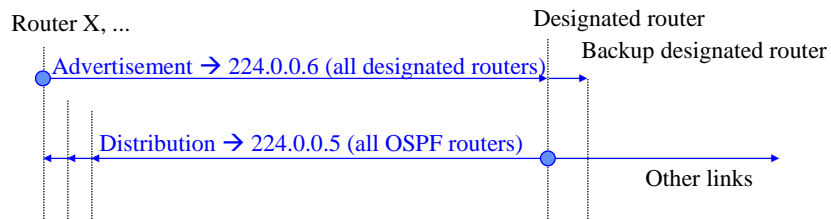

⇒ No need to process acks from all other routers in the subnet

Backup designated stays as silent as possible

OSPF flooding protocol in a non-broadcast network

- In non-broadcast networks (e.g. X.25, ATM, frame relay), OSPF works in the same way except that broadcasts are replaced by point-to-point messages

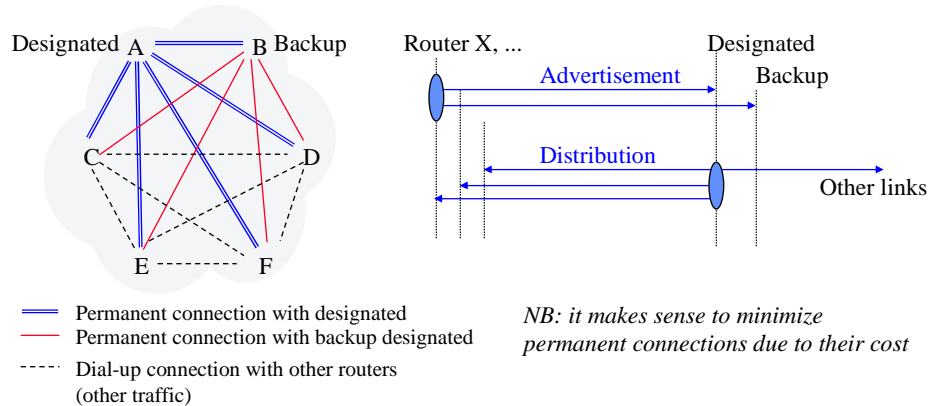

S-38.2121 / Fall-07 / RKa, NB

LS-54

The purpose of hierarchical routing in OSPF is to reduce routing table growth

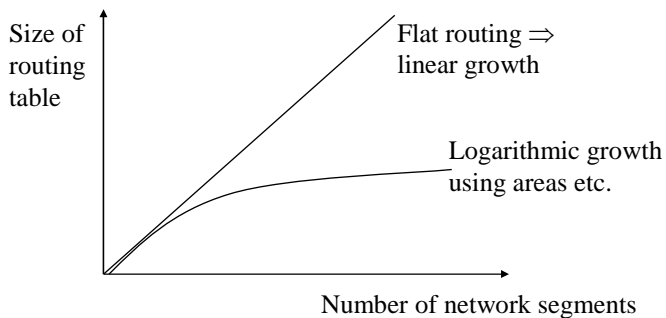

The cost is: sometimes suboptimal routes.

S-38.2121 / Fall-07 / RKa, NB

LS-55

OSPF supports 4 level routing hierarchy

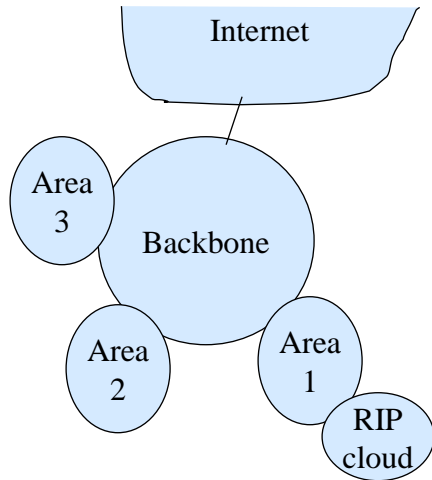

Level	Description
1	Intra-area routing
2	Inter-area routing
3	External Type 1 metrics
4	External Type 2 metrics

- Type 1 metrics are of the same order as OSPF metrics, e.g. hop count (for RIP and OSPF)
- Type 2 metrics are always more significant than OSPF internal metrics (e.g. BGP-4)

S-38.2121 / Fall-07 / RKa, NB

LS-56

By breaking down a large network into areas, OSPF eases flooding and reduces the size of link DBs

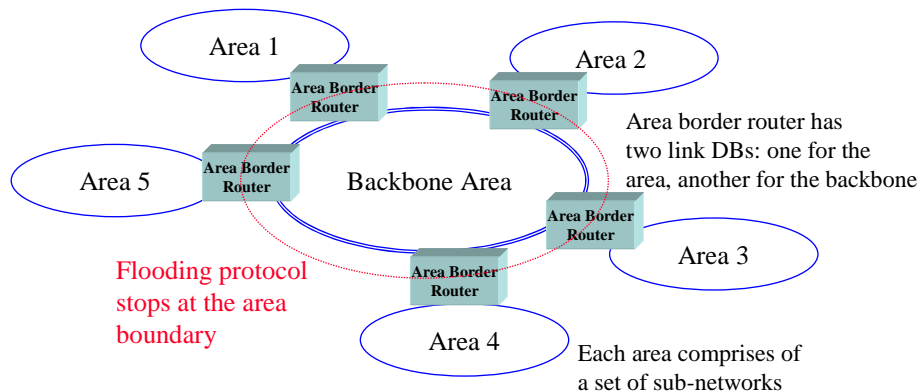

All OSPF routers within an area have identical link databases

S-38.2121 / Fall-07 / RKa, NB

LS-57

(Sub)networks of other areas are described in summary records – the metric is computed in “RIP-style”

Link DB for Area A:

- a1, a2, a3
- **Summary records** of the subnets in the backbone and Area C
 - ← AB2, AB4
 - Distance $ABx - bz$ or $ABx - BC3 - cy$ (metrics are summed).
- **External records**
 - ← AB2, AB4
 - Same information in all areas
 - Also summary records for BB0 and BB1 are required

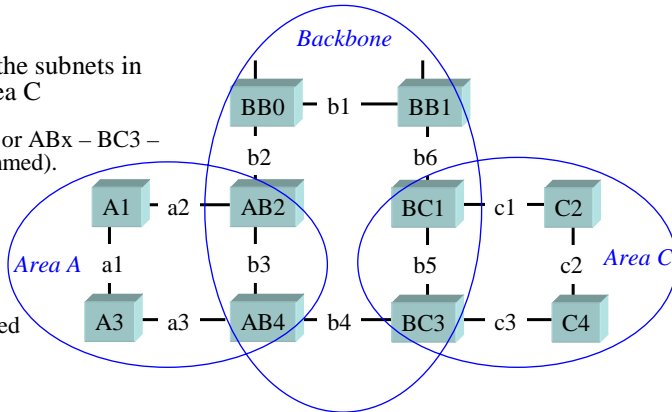

Hierarchy:
 areas are only connected through the backbone
 ⇒ No loops

OSPF easily recovers from failures in areas

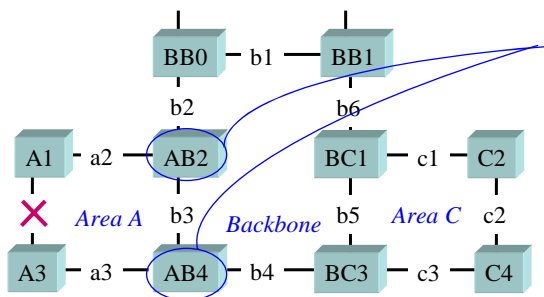

AB2 and AB4 advertise only those subnets which they can reach:
 AB2: a2 and AB4: a3.

Backbone does not know exact structure of area A – but it knows identities of all reachable subnets.

A virtual link can help if backbone splits into isolated segments due to a failure

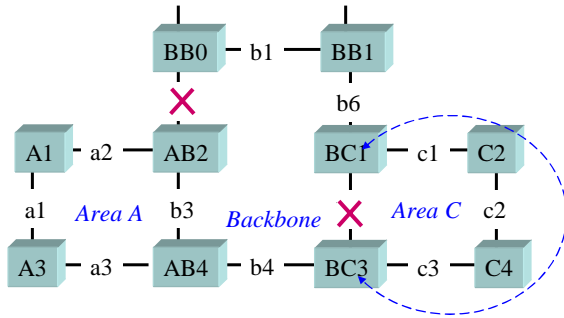

Virtual link through Area C:
distance=c1+c2+c3

Must be configured
by administrator

There is no point in advertising all external routes to an area with only one area border router

- In a **Stub Area**, all external routes are summed to the default route
 - If an OSPF area has *only one* area border router, all traffic to and from the Internet goes through this ABR. It is not useful to advertise all Internet routes separately towards such an area.
 - There can even be *several* ABRs, but it is not possible to select the best of them based on destination prefix (leading bits (<32) of IP address)
- A “**Not So Stubby Area**” (NSSA) is an area, in which all external routes have been summarized into the default route *except for some*.

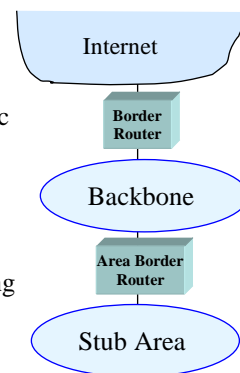

OSPF link state records

Link State Advertisement (LSA) types in OSPF

- LS Type = 1 **Router LSA**
 - Describes a set of links starting from a router
- LS Type = 2 **Network LSA**
 - describes a network segment (BC or NBMA) along with the IDs of currently attached routers
- LS Type = 3 **Summary LSA for IP Network**
- LS Type = 4 **Summary LSA for Border Router**
- LS Type = 5 **External LSA**
 - describes external routes
- LS Type = 6 **Group Membership LSA**
 - used in MOSPF for multicast routing
- LS Type = 7 **Not So Stubby Area LSA**
 - to import limited external info
- LS Type = 8 (proposed) **external attributes LSA**
 - in lieu of Internal BGP

} Hierarchical
Routing

BC = Broadcast, e.g. Ethernet
NBMA = Non-Broadcast
Multiple Access, e.g. ATM

Common header of Link State Advertisement (LSA)

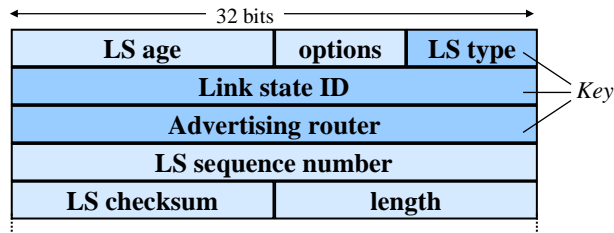

LS age:

- Seconds from advertisement

Options:

- E-bit = external links
- T-bit = type of service support
 - when many metrics are in use

LS checksum:

- Protects header and content

Length:

- Total length of the record

Link state ID:

- Depends on LS type

LSA Sequence Numbers

- "Lollipop sequence space"

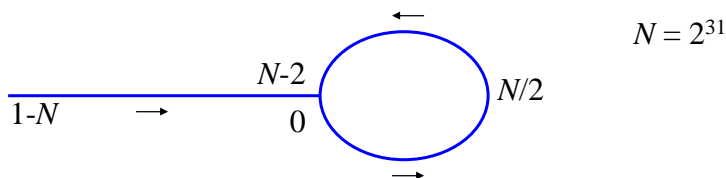

- If one of the numbers is < 0
 - The higher number is newer
- If both numbers are ≥ 0 , assuming $b > a$
 - If $(b-a) < (N-1)/2$ then b is newer

Router LSA (type 1)

Describes links starting from a router.

for each link	RouterType	0	Number of links
	Link ID		
	Link data		
	LinkType	# TOS	TOS 0 metric
	TOS=x	0	TOS x metric
	TOS=y	0	TOS y metric
...			
TOS=z	0	TOS z metric	

Router type

- E-bit (External)
 - This router is an area-border router
- B-bit (Border)
 - This router is a border router

Link type

1. Link is a *point-to-point link* to another router
 - Link ID = neighboring router's OSPF ID
 - Link data = router's interface address
2. Link connects to a *transit network*
 - Link ID = IP address of designated router's interface
 - Link data = router's interface address
3. Link connects to a *stub network*
 - Link ID = Network/subnet number
 - Link data = network/subnet mask

Router LSA example

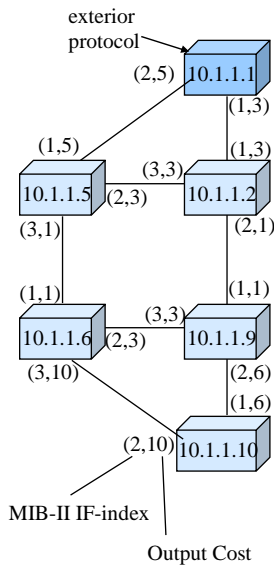

Router 10.1.1.1's router-LSA:

	LS Age = 0 seconds	Options	LS type=1	E-bit
	Link State ID = 10.1.1.1			1=Router LSA
	Advertising Router = 10.1.1.1			
	LS Sequence Number = 0x80000006			
	Checksum= 0x9b47	Length = 60 bytes		
0=ordinary	RouterType=0	0	Nrof links = 3	
	Link ID = 10.1.1.2 (neighb)			
	Link Data = IF-index 1 (unnum)			
1=pt-to-pt	Type=1	#TOS=0	Metric=3	
	Link ID = 10.1.1.5 (neighb)			
	Link Data = IF-index 2 (unnum)			
1=pt-to-pt	Type=1	#TOS=0	Metric=5	
	Link ID = 10.1.1.1			
	Link Data = 255.255.255.255			
3=stub network	Type=3	#TOS=0	Metric=0	

Length = 24 + 3 * 12 = 60 bytes

Router with 100 interfaces:

- Length = 24 + 100 * 12 = 1224 bytes

Network LSA (type 2)

Network mask
Attached router
Attached router
...
Attached router

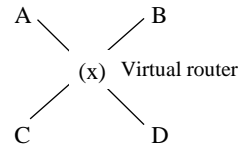

- Advertised by designated routers for transit networks
- Link state ID (in header) = interface ID of designated router
- Attached router = OSPF identifier of the attached router

Network LSA example

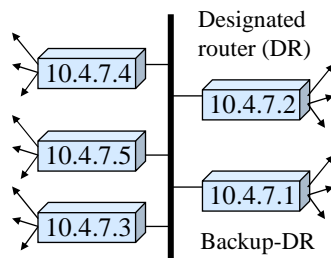

Link to transit network in all Router LSAs:

(header)		
Flags=0	0	Number of links
Link ID = 10.4.7.2		
Link Data = 10.4.7.3		
Type=2	#TOS=0	Metric = 1
(more links)		

Network LSA is generated by DR:

(header)
Mask = 255.255.255.248
Router1 = 10.4.7.1
Router2 = 10.4.7.2
Router3 = 10.4.7.3
Router4 = 10.4.7.4
Router5 = 10.4.7.5

- Corresponds to the “virtual router”
- Network LSA reduces number of link records from $O(n \cdot (n-1))$ to $2 \cdot n$.
 - Particularly important if the network is ATM or Frame Relay with a lot of routers attached!

Summary Link LSA (type 3,4)

Network mask		
0	0	TOS 0 metric
TOS=x	0	TOS x metric
TOS=y	0	TOS y metric
...		
TOS=z	0	TOS z metric

- For *IP networks* (type 3)
 - Network mask of network/subnet
 - Link state ID (in header) = IP network/subnet number
- For *border routers* (type 4)
 - Network mask = 0xFFFFFFFF
 - Link state ID (in header) = IP address of border router
- One separate advertisement for each destination

External Link LSA (type 5)

Network mask		
E,TOS=0	0	TOS 0 metric
External route tag (0)		
E,TOS=x	0	TOS x metric
External route tag (x)		
...		
E,TOS=z	0	TOS z metric
External route tag (z)		

- Link state ID (in header) = IP network/subnet of destination
- Network mask = network/subnet mask
- E-bit indicates that distance is not comparable to internal metrics
 - Larger than any internal metric
- Route tag is only used by border routers (not used by OSPF)
- Advertised by border routers
 - Information from external gateway protocols (BGP-4)
- One destination per record

Routes are computed after a change in the topology

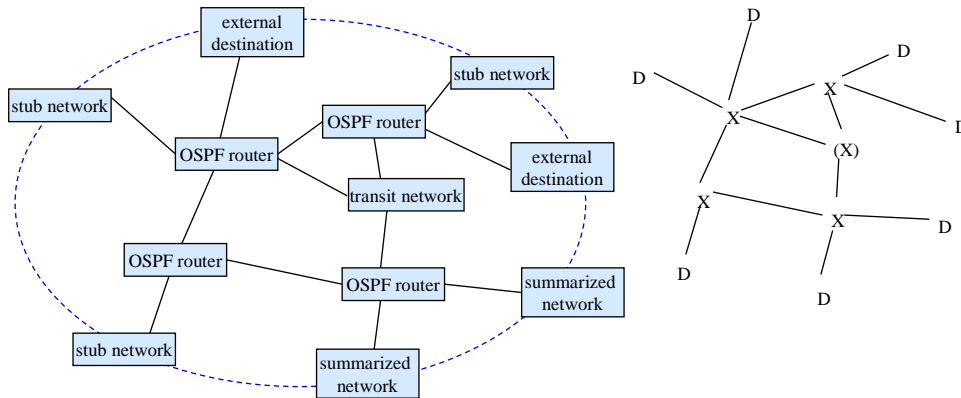

- Separate routes for each TOS and for TOS 0
 - Possibly unreachable destinations for some TOS if not all routers support TOS \Rightarrow routed with TOS 0 (no loops because same decision in all nodes)

Nonbroadcast multiaccess (NBMA) subnets support many routers communicating directly but do not have broadcast capability

- Examples are ATM, Frame Relay, X.25
- IP routing requires more manual configuration
- Designated router and backup DR concept reduce the number of adjacencies
- The model is prone to failures that may be hard to track

Point-to-multipoint subnet is more robust but less efficient

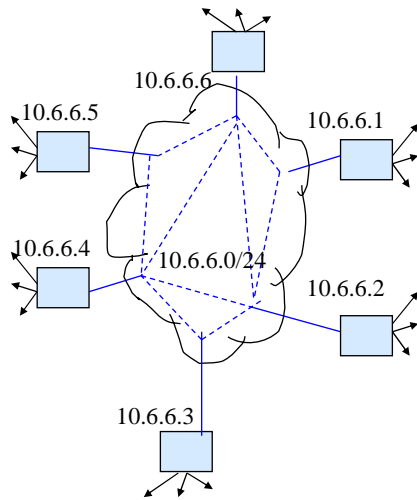

S-38.2121 / Fall-07 / RKa, NB

LS-75

- There is no DR nor backup DR
- Every OSPF router maintains adjacencies with all neighbors with whom it has direct connectivity
- Alternative is a set of NBMA networks
- Next hop routing protocol improves scalability

The OSPF protocol

S-38.2121 / Fall-07 / RKa, NB

LS-76

OSPF packets – the protocol itself

- OSPF works directly on top of IP.
 - OSPF protocol number is 89.
- Destination IP address =
 - Neighbors IP address or
 - AllOSPF Routers (224.0.0.5) or
 - AllDesignated Routers (224.0.0.6) or
 - Peer IP address (on virtual links)
- OSPF has 3 sub-protocols:
 - Hello protocol
 - Exchange protocol
 - Flooding protocol

The common OSPF message header

Version	Type	Packet length
Router ID		
Area ID		
Checksum	Authentic. type	
Authentication		
Authentication		

Type differentiates messages

- Type 1: Hello
- Type 2: Database Description
- Type 3: Link State Request
- Type 4: Link State Update
- Type 5: Link State Ack

- Current version of OSPF is 2
- Area ID
 - Usually a (sub)network number
 - 0 = Backbone
- Authentication type
 - 0 = No authentication
 - 1 = Password
 - Limited protection
 - 2 = Cryptographic authentication
 - MD5

0	Key ID	Length
Cryptographic sequence number		

The Hello protocol ensures that links are working and selects the Designated Router and Backup DR

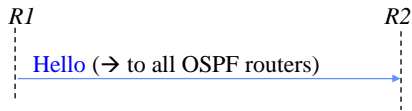

- Neighbors – a list of neighbors that have sent a hello packet during last dead interval seconds.
 - Hello interval – how often hello packets are sent (in seconds).
 - Priority – the eligibility for the role of designated router.
- ☞ A hello packet must be sent in both directions before a link is considered operational

OSPF packet header type = 1		
Network mask		
Hello interval	Options	Priority
Dead interval		
Designated router		
Backup designated router		
Neighbor		
- - -		
Neighbor		

- Options
 - E = external route capability.
 - T = TOS routing capability.
 - M = Multicast capability (MOSPF).
- DR and Backup DR = 0 if not known

The Hello protocol selects the Designated Router and Backup DR

Eligibility is achieved after one dead interval provided two-way reachability is OK.

- If one or several neighbors proposed themselves as backup designated router the one with highest priority is elected to backup DR. Tie is broken by electing the one with highest ID.
- If no neighbor proposed itself to backup DR, the neighbor with the highest priority is selected. Tie is broken by selecting the one with highest ID.
- If one or several neighbors proposed themselves as designated router, the one with the highest priority is selected. Tie is broken by selecting the one with highest ID.
- If none proposed itself to DR, the backup DR is promoted. Actions 1 and 2 are repeated to re-select the backup DR.

To minimize changes, a high priority former DR postpones its proposal to retake the position of DR after recovery. Actions 1-4 are continuous.

The Exchange protocol initially synchronizes link DB with the designated router (1)

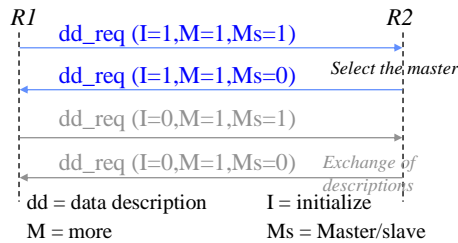

OSPF packet header type = 2 (dd)			
0	0	Options	0 I,M,Ms
dd sequence number			

- Exchange protocol uses database description packets
- First the master and slave are selected

- If both want to be masters, the highest address wins
- Retransmission if the packet is lost
- The same sequence number in the replies

The Exchange protocol initially synchronizes link DB with the designated router (2)

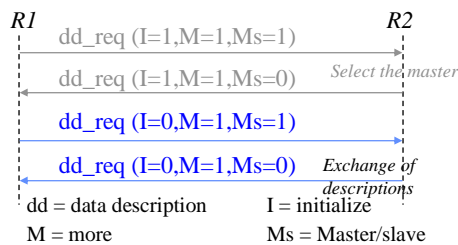

OSPF packet header type = 2 (dd)	
0	0 Options 0 I,M,Ms
dd sequence number	
Link state type	
Link state ID	
Advertising router	
Link state sequence number	
Link state checksum	Link state age
...	

- Master sends its Link DB description in sequence numbered packets
- Slave acknowledges by sending its corresponding description packets.

- Exchange continues until all descriptions are sent and acknowledged. (M=0)
- Differences are recorded on the list of "records-to-request".

Request packets are used to get record contents

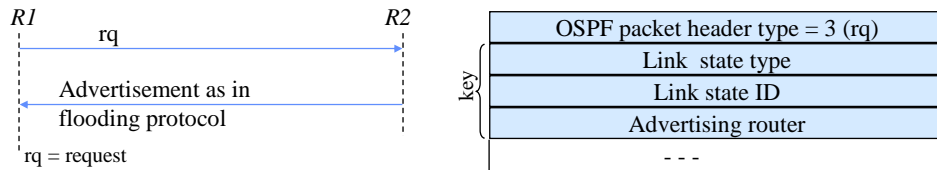

- Router waits for ack for 'resend interval'. If no response, the request is repeated.
- The records to request may be split into many requests, there are too many.
- If something goes wrong, the typical remedy is to restart role negotiation.
- The first request can be sent immediately when the first differing record has been detected. Then dd-packet exchange and rq packet exchange take place in parallel.
- Requests are acknowledged by flooding protocol packets

The Flooding protocol continuously maintains the area's Link DB integrity

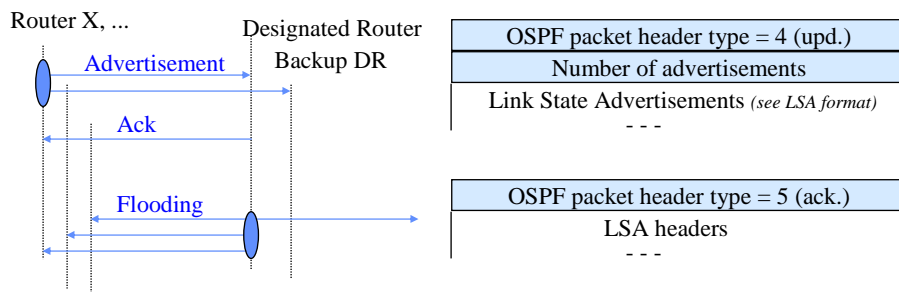

- Original LSA is always sent by the router responsible for that link.
- Advertisement is distributed according to flooding rules to the area (age=age+1).
- Ack of a new record by DR can be replaced in BC network by update message.
- One ack packet can acknowledge may LSAs.
- By delaying, several acks are collected to a single packet

Summary of OSPF subprotocols

Message Protocol	Hello (1)	DD (2)	LS rq (3)	LS upd (4)	LS ack (5)
Hello protocol	X				
Database exchange		X	X	X	X
Flooding protocol				X	X

Server Cache Synchronization Protocol (SCSP) is OSPF without Dijkstra's algorithm and with more generic data objects.

Link records have an age, old/dead ones are removed from Link DB (1)

- Old information must be removed from DB
- Every node must use the same information
 - ⇒ The removals must be synchronized
- The LSAs of OSPF have an age
 - Age = 0 when the advertisement is created
 - Age = number of hops through which the advertisement has traveled + seconds from reception
- Max age is 1 hour
 - Not used in the calculation of routes
 - Must be removed
- Every entry must be advertised at a 30 min interval.
 - The new advertisement zeroes the age and increments the sequence number.

Link records have an age, old/dead ones are removed from Link DB (2)

- When the age reaches MaxAge (= 1 h) the entry is removed
 - The router must send an advertisement to the neighbors when the aged entry is removed
- The flooding algorithm examines the age of the received advertisement
 1. MaxAge advertisement is accepted and flooded – this removes obsolete info.
 2. If the age difference of the advertisement to the DB is small, the advertisement is not flooded to avoid overloading the network with multiple copies of the same info. This is due to normal routing when the entry is received on different paths.
 3. If the age difference is large ($> \text{MaxAgeDiff}$), the newest advertisement is accepted and distributed. In this case, the router has probably been restarted.
 4. If a MaxAge record is not found, advertisement has not impact. The router most likely has already removed the dead LSA.

OSPF timeouts – LS Age field

Constant	Value	Action of OSPF router
MinLSArrival	1 second	Max rate at which a router will accept updates of any LSA via flooding
MinLSInterval	5 seconds	Max rate at which a router can update an LSA
CheckAge	5 min	Rate to verify an LSA Checksum in DB
MaxAgeDiff	15 min	When Ages differ more than 15 min, they are considered separate. Smaller LS age - newer!
LSRefreshTime	30 min	A Router must refresh any self-originated LSA whose age has reached 30 min.
MaxAge	1 hour	LSA is removed from DB.

Why is it difficult to route packets around network congestion?

- BBN ARPANET link state metric varied with the length of the output queue of the link \Rightarrow lead to route trashing.
- The problem is there is no route pin-down for existing traffic.
- By limiting the range of the metric changes, an equilibrium could be reached. Nevertheless routing instability is the problem.

When QoS or Class of Service a'la DiffServ is introduced this problem again becomes important.

OSPF development history

